

# O2.5UMA-NRG

Multi-Deck Mobile Self-Contained Merchandiser  
4' & 6' Case (Dairy/Deli/Meat/Produce/Seafood)

## GENERAL NOTES

- "---" indicates that the feature is not an option for this case model and/or the data is not yet available.
- LED lights only.
- Maximum of 2 rows of standard output LED lighted shelves.
- Nose lights are not available.

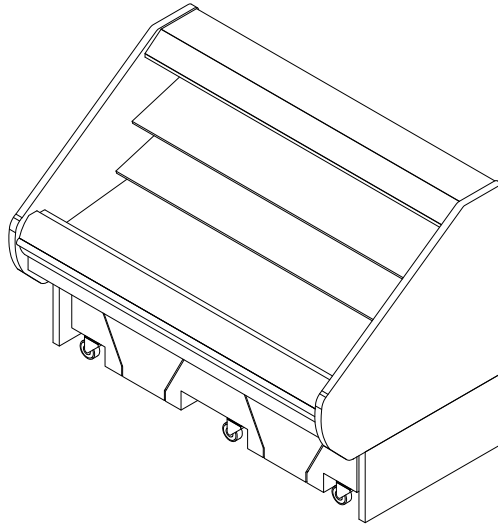

SHIPPING WEIGHT	
Case	Weight
O2.5UMA-NRG	---



COMPONENT

ALL MEASUREMENTS ARE TAKEN PER ASHRAE-72-2005 SPECIFICATIONS. HILLPHOENIX REFRIGERATED DISPLAY CASES FOR SALE IN THE UNITED STATES MEET OR EXCEED DEPARTMENT OF ENERGY 2017 REQUIREMENTS.

## O2.5UMA-NRG

Rev Date:	Rev #	Revision Description:
9-19-18	3	DATA UPDATE
8-13-18	2	NEW STANDARDS

**Hillphoenix**  
A DOVER COMPANY

# O2.5UMA-NRG

Multi-Deck Mobile Self-Contained Merchandiser  
4' & 6' Case (Dairy/Deli/Meat/Produce/Seafood)

SYSTEM REQUIREMENTS					
Case Length	Volts	Phase	Frequency	Plug Style	Cord Length
4'	120	1	60	NEMA L5-20	10'
6'	120	1	60	NEMA L5-20	10'
6'	208/230	1	60	NEMA L14-30	10'

GUIDELINES AND CONTROL SETTINGS			
Suction Pressure @ Case Outlet (psig)	Superheat Set Point @ Bulb (°F)	Discharge Air (°F)	Discharge Air Velocity (FPM)
40	6 - 8	26	225

CONDENSING UNIT DATA								
Case Length	Volts	Phase	Frequency (Hz)	Horsepower	Running Load Amps (RLA) (Amps)	Locked Rotor Amps (LRA) (Amps)	Refrigerant	Lbs. of Refrigerant
4'	120	1	60	1/2	10.5	54.5	R404A	3.6
6'	120	1	60	3/4	15.0	70.0	R404A	4.3
6'	208/230	1	60	3/4	6.1	40.0	R404A	4.3

DEFROST CONTROLS		
Defrosts Per Day	Timed-Off Defrost	
	Fail-Safe (Min)	Termination Temp (F)
6	45	47

## NOTES

- Listed BTUH/ft data represent unlighted shelves. For LED lighting, add 9 BTUH/ft per row of lighted shelving.
- BTUH load increases by 123 BTUH/ft when aftermarket merchandising accessories are utilized.
- Listed evaporator temperature represents unlighted shelves. For lighted shelves and/or aftermarket merchandising accessories, reduce the listed evaporator temperature by 2°F.
- Conventional Discharge Air Control - Recommended Settings: Cut-in Temp + Discharge Air + 2°F; Cut-Out Temp = Discharge Air - 2°F.
- Listed discharge air velocity represents the average velocity immediately after defrost.
- Temperature and defrost settings listed above are recommended start-up settings. Final operational settings may need to be adjusted for the store conditions in which the case operates.



## O2.5UMA-NRG

ALL MEASUREMENTS ARE TAKEN PER ASHRAE-72-2005 SPECIFICATIONS. HILLPHOENIX REFRIGERATED DISPLAY CASES FOR SALE IN THE UNITED STATES MEET OR EXCEED DEPARTMENT OF ENERGY 2017 REQUIREMENTS.

Rev Date:	Rev #	Revision Description:
9-19-18	3	DATA UPDATE
8-13-18	2	NEW STANDARDS



A DOVER COMPANY

# O2.5UMA-NRG

Multi-Deck Mobile Self-Contained Merchandiser  
4' & 6' Case (Dairy/Deli/Meat/Produce/Seafood)

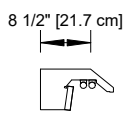
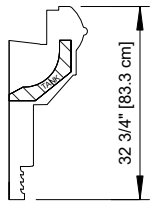
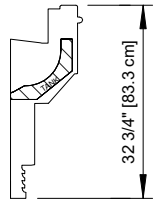
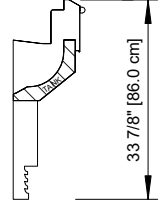
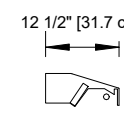
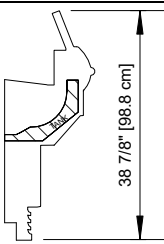
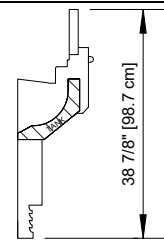
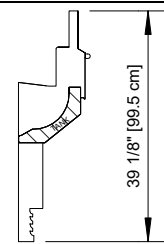
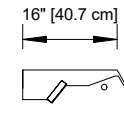
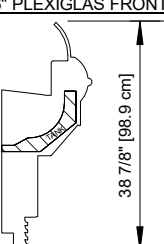
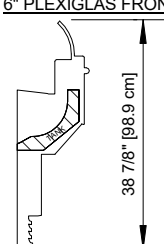
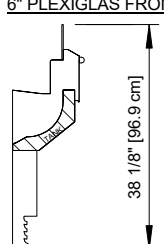
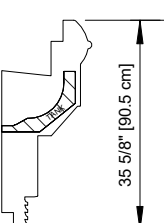
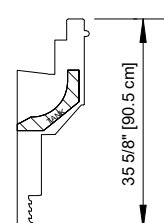
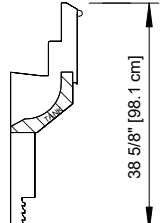
<b>REAR SILL OPTIONS</b>	<b>FRONT OPTIONS</b>			
	<b>ORIGIN 2 FRONT</b>	<b>FLAT FRONT FLAT TOP</b>	<b>FLAT FRONT ANGLED TOP</b>	<b>FLAT FRONT ANGLED TOP</b>
<b>STANDARD REAR SILL</b>   8 1/2" [21.7 cm]	<b>STANDARD FRONT</b>   32 3/4" [83.3 cm]	<b>STANDARD FRONT</b>   32 3/4" [83.3 cm]	<b>STANDARD FRONT</b>   33 7/8" [86.0 cm]	
<b>12 1/2" REAR SILL</b>   12 1/2" [31.7 cm]	<b>6" THERMOPANE FRONT</b>   38 7/8" [98.8 cm]	<b>6" THERMOPANE FRONT</b>   38 7/8" [98.7 cm]	<b>6" THERMOPANE FRONT</b>   39 1/8" [99.5 cm]	
<b>16" REAR SILL (REAR DISCHARGE)</b>   16" [40.7 cm]	<b>6" PLEXIGLAS FRONT</b>   38 7/8" [98.9 cm]	<b>6" PLEXIGLAS FRONT</b>   38 7/8" [98.9 cm]	<b>6" PLEXIGLAS FRONT</b>   38 1/8" [96.9 cm]	
	<b>EXTENDED STANDARD FRONT</b>   35 5/8" [90.5 cm]	<b>EXTENDED STANDARD FRONT</b>   35 5/8" [90.5 cm]	<b>EXTENDED STANDARD FRONT</b>   38 5/8" [98.1 cm]	

## NOTES

- Front and rear sill heights vary with base frame height.
- Extended front sills are required on meat applications to maintain proper product temperature.



## O2.5UMA-NRG

ALL MEASUREMENTS ARE TAKEN PER ASHRAE-72-2005 SPECIFICATIONS. HILLPHOENIX REFRIGERATED DISPLAY CASES FOR SALE IN THE UNITED STATES MEET OR EXCEED DEPARTMENT OF ENERGY 2017 REQUIREMENTS.

Rev Date:	Rev #	Revision Description:
9-19-18	3	DATA UPDATE
8-13-18	2	NEW STANDARDS



# O2.5UMA-NRG

## Multi-Deck Mobile Self-Contained Merchandiser 4' & 6' Case (Dairy/Deli/Meat/Produce/Seafood)

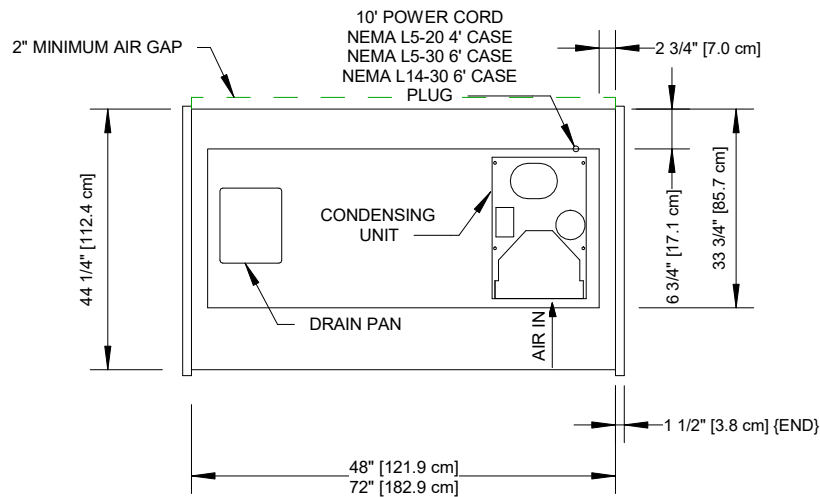
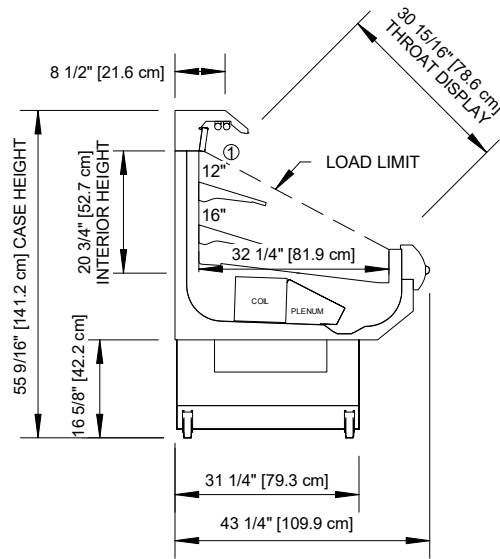

### NOTES

- \* :STUB-UP AREA
- \*\* :RECOMMENDED STUB-UP CENTERLINE FOR ELECTRICAL AND HUB DRAINS AVAILABLE UPON REQUEST
- ① :AVAILABLE SHELF SIZES: 10", 12", 14" & 16"

- Ends add approximately 1 inch to case height.
- Product on top shelf should be 3 inches below discharge.



### O2.5UMA-NRG

ALL MEASUREMENTS ARE TAKEN PER ASHRAE-72-2005 SPECIFICATIONS. HILLPHOENIX REFRIGERATED DISPLAY CASES FOR SALE IN THE UNITED STATES MEET OR EXCEED DEPARTMENT OF ENERGY 2017 REQUIREMENTS.

Rev Date:	Rev #	Revision Description:
9-19-18	3	DATA UPDATE
8-13-18	2	NEW STANDARDS

