

O2.5UM-NRG

Multi-Deck Merchandiser with Synergy-E™
4', 6', 8', 12' Case (Dairy/Deli/Meat/Produce/Seafood)

GENERAL NOTES

- "---" indicates that the feature is not an option with this case model and/or the data is not available at this time.
- LED lights only.
- Maximum of 2 rows of standard output LED lighted shelves.
- Nose lights are not available.

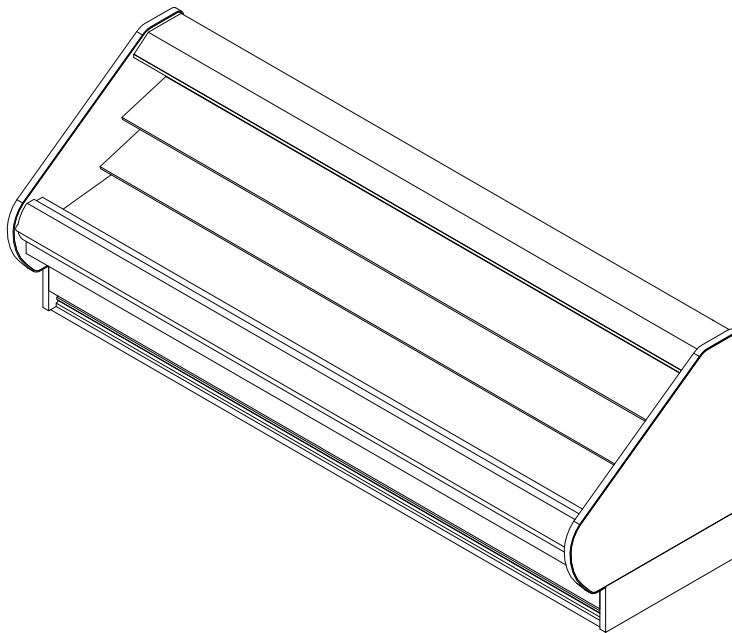

SHIPPING WEIGHT	
Case	Weight
O2.5UM-NRG	---



ALL MEASUREMENTS ARE TAKEN PER ASHRAE-72-2005 SPECIFICATIONS. HILLPHOENIX REFRIGERATED DISPLAY CASES FOR SALE IN THE UNITED STATES MEET OR EXCEED DEPARTMENT OF ENERGY 2017 REQUIREMENTS.

O2.5UM-NRG

Rev Date:	Rev #	Revision Description:
9-10-18	3	DATA UPDATE
5-22-18	2	NEW STANDARDS

Hillphoenix
A DOVER COMPANY

O2.5UM-NRG

Multi-Deck Merchandiser with Synergy-E™
4', 6', 8', 12' Case (Dairy/Deli/Meat/Produce/Seafood)

ELECTRICAL DATA			
Case Length	Fans Per Case	High Efficiency Fans	
		120 Volts	
		Amps	Watts
4'	1	0.16	11
6'	2	0.32	22
8'	2	0.32	22
12'	3	0.48	33

LIGHTING DATA						
Case Length	Lights Per Row	Light Length	Clearvoyant LED Lighting (Per Light Row)			
			Standard Power (Cornice or Shelf)		High Power (Cornice)	
			120 Volts		120 Volts	
			Amps	Watts	Amps	Watts
4'	1	4'	0.05	5.9	0.12	14.9
6'	2	3'	0.08	9.4	0.20	23.8
8'	2	4'	0.10	11.8	0.25	29.8
12'	3	4'	0.15	17.7	0.37	44.7

GUIDELINES AND CONTROL SETTINGS							
Application	Front Sill Height	BTUH/ft		Superheat Set Point @ Bulb (°F)	Evaporator (°F)	Discharge Air (°F)	Discharge Air Velocity (FPM)
		Conventional	Parallel				
Dairy / Deli / Produce	All	858	750	6 - 8	28	31	180
Meat	Extended	847	740	6 - 8	26	30	180

DEFROST CONTROLS		
Defrosts Per Day	Timed-Off Defrost	
	Fail-Safe (Min)	Termination Temp (°F)
6	30	47

NOTES

- "----" indicates that the feature is not an option with this case model and/or the data is not available at this time.
- Listed BTUH/ft data represent unlighted shelves. For LED lighting, add 9 BTUH/ft per row of lighted shelving.
- Rear refrigerated box increases refrigeration load by 110 BTUH/ft.
- BTUH load increases by 132 BTUH/ft when aftermarket merchandising accessories are utilized.
- Listed evaporator temperature indicates unlighted shelves. For lighted shelves and/or aftermarket merchandising accessories, reduce the listed evaporator temperature by 2°F.
- Conventional Discharge Air Control – Recommended Settings: Cut-In Temp = Discharge Air + 2°F; Cut-Out Temp = Discharge Air - 2°F
- Listed discharge air velocity represents the average velocity immediately after defrost.
- Temperature and defrost settings listed above are recommended start-up settings. Final operational settings may need to be adjusted for the store conditions in which the case operates.
- The recommended evaporator temperatures may need to be adjusted based on system setup, store conditions, etc. The minimum recommended evaporator temperature is 4°F below the listed evaporator temperature.



ALL MEASUREMENTS ARE TAKEN PER ASHRAE-72-2005 SPECIFICATIONS. HILLPHOENIX REFRIGERATED DISPLAY CASES FOR SALE IN THE UNITED STATES MEET OR EXCEED DEPARTMENT OF ENERGY 2017 REQUIREMENTS.

O2.5UM-NRG

Rev Date:	Rev #	Revision Description:
9-10-18	3	DATA UPDATE
5-22-18	2	NEW STANDARDS

Hillphoenix
A BOWEN COMPANY

O2.5UM-NRG

Multi-Deck Merchandiser with Synergy-E™
4', 6', 8', 12' Case (Dairy/Deli/Meat/Produce/Seafood)

SECOND NATURE DATA								
Case Model	No. of Coils	Application	Front Sill Type	BTUH/ft (DR)		GPM/ft	Supply Fluid Temp (°F)	Disc. Air Temp (°F)
				Conventional	Parallel			
O2.5UM-NRG	1	Bulk Produce	All Fronts	858	750	0.10	20	37
O2.5UM-NRG	1	Deli / Produce	All Fronts	858	750	0.22	20	31
O2.5UM-NRG	1	Meat	33" Front	847	740	0.26	20	30
O2.5UM-NRG	1	Bulk Produce	All Fronts	858	750	0.18	25	37
O2.5UM-NRG	1	Deli / Produce	All Fronts	858	750	0.56	25	31
O2.5UM-NRG	1	Meat	33" Front	847	740	0.77	25	30

SECOND NATURE DATA								
Case Model	No. of Coils	Application	Front Sill Type	No. Def.	Timed Off Defrost		Warm Fluid Defrost	
					Fail Safe (Min)	Termination Temp (°F)	Fail Safe (Min)	Termination Temp (°F)
O2.5UM-NRG	1	Bulk Produce	All Fronts	6	60	47	26	49
O2.5UM-NRG	1	Deli / Produce	All Fronts	6	60	47	26	49
O2.5UM-NRG	1	Meat	33" Front	6	60	47	26	49
O2.5UM-NRG	1	Bulk Produce	All Fronts	6	45	42	26	49
O2.5UM-NRG	1	Deli / Produce	All Fronts	6	45	42	26	49
O2.5UM-NRG	1	Meat	33" Front	6	45	42	26	49



ALL MEASUREMENTS ARE TAKEN PER ASHRAE-72-2005 SPECIFICATIONS. HILLPHOENIX REFRIGERATED DISPLAY CASES FOR SALE IN THE UNITED STATES MEET OR EXCEED DEPARTMENT OF ENERGY 2017 REQUIREMENTS.





O2.5UM-NRG

Rev Date:	Rev #	Revision Description:
9-10-18	3	DATA UPDATE
5-22-18	2	NEW STANDARDS

Hillphoenix
A BOWEN COMPANY

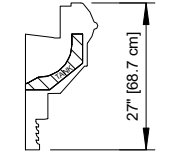
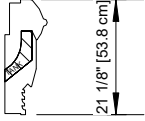
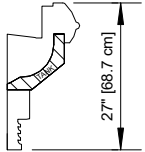
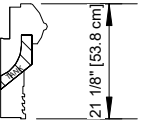
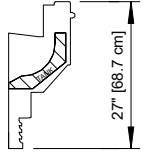
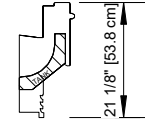
O2.5UM-NRG

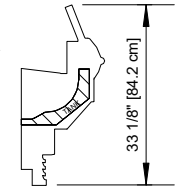
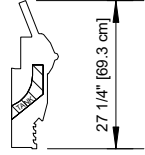
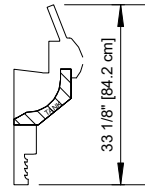
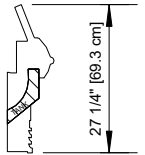
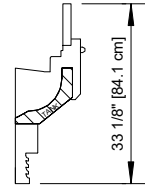
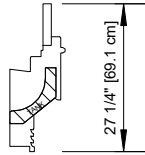
Multi-Deck Merchandiser with Synergy-E™
4', 6', 8', 12' Case (Dairy/Deli/Meat/Produce/Seafood)

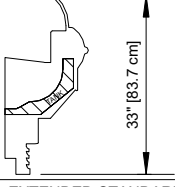
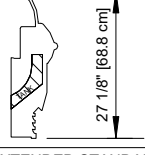
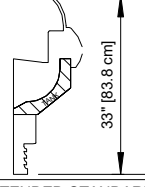
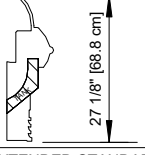
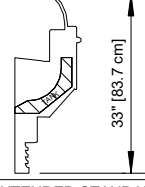
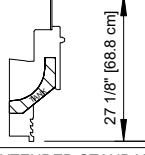
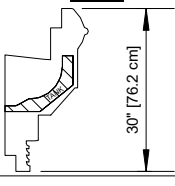
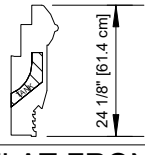
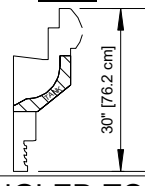
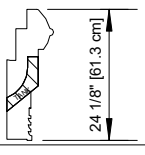
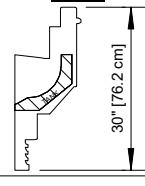
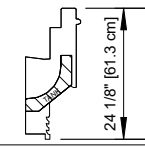
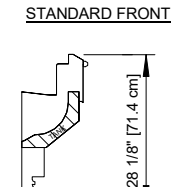
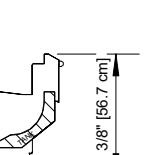
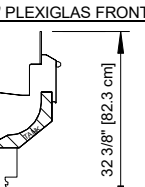
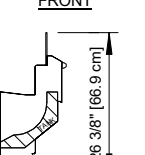
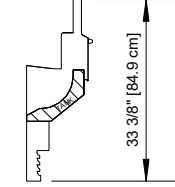
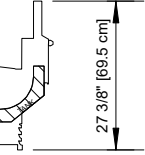
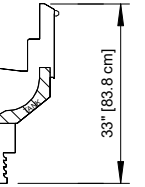
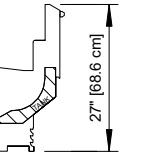
REAR SILL OPTIONS	FRONT OPTIONS					
	ORIGIN 2 FRONT				FLAT FRONT FLAT TOP	
	STANDARD FRONT	STANDARD FRONT	STANDARD FRONT	STANDARD FRONT	STANDARD FRONT	STANDARD FRONT
STANDARD REAR SILL 8 1/2" [21.7 cm] 	 27" [68.7 cm]	 21 1/8" [53.8 cm]	 27" [68.7 cm]	 21 1/8" [53.8 cm]	 27" [68.7 cm]	 21 1/8" [53.8 cm]
12 1/2" REAR SILL 12 1/2" [31.7 cm] 	 33 1/8" [84.2 cm]	 27 1/4" [69.3 cm]	 33 1/8" [84.2 cm]	 27 1/4" [69.3 cm]	 33 1/8" [84.1 cm]	 27 1/4" [69.1 cm]
16" REAR SILL (REAR DISCHARGE) 16" [40.7 cm] 	 33" [83.7 cm]	 27 1/8" [68.8 cm]	 33" [83.8 cm]	 27 1/8" [68.8 cm]	 33" [83.7 cm]	 27 1/8" [68.8 cm]
	EXTENDED STANDARD FRONT  30" [76.2 cm]	EXTENDED STANDARD FRONT  24 1/8" [61.4 cm]	EXTENDED STANDARD FRONT  30" [76.2 cm]	EXTENDED STANDARD FRONT  24 1/8" [61.3 cm]	EXTENDED STANDARD FRONT  30" [76.2 cm]	EXTENDED STANDARD FRONT  24 1/8" [61.3 cm]
	FLAT FRONT ANGLED TOP					
	STANDARD FRONT  28 1/8" [71.4 cm]	STANDARD FRONT  22 3/8" [56.7 cm]	6" PLEXIGLAS FRONT  32 3/8" [82.3 cm]	6" PLEXIGLAS FRONT  26 3/8" [66.9 cm]		
	6" THERMOPANE FRONT  33 3/8" [84.9 cm]	6" THERMOPANE FRONT  27 3/8" [69.5 cm]	EXTENDED STANDARD FRONT  33" [83.8 cm]	EXTENDED STANDARD FRONT  27" [68.6 cm]		

NOTES:

- Front and rear sill heights vary with base frame height
- Extended front sills are required on meat applications to maintain proper product temperature. An extended front has a minimum height of 24" on a 5" baseframe, or 30" on an 11" baseframe.



O2.5UM-NRG

ALL MEASUREMENTS ARE TAKEN PER ASHRAE-72-2005 SPECIFICATIONS. HILLPHOENIX REFRIGERATED DISPLAY CASES FOR SALE IN THE UNITED STATES MEET OR EXCEED DEPARTMENT OF ENERGY 2017 REQUIREMENTS.

Rev Date:	Rev #	Revision Description:
9-10-18	3	DATA UPDATE
5-22-18	2	NEW STANDARDS



A BOWEN COMPANY

O2.5UM-NRG

Multi-Deck Merchandiser with Synergy-E™
4', 6', 8', 12' Case (Dairy/Deli/Meat/Produce/Seafood)

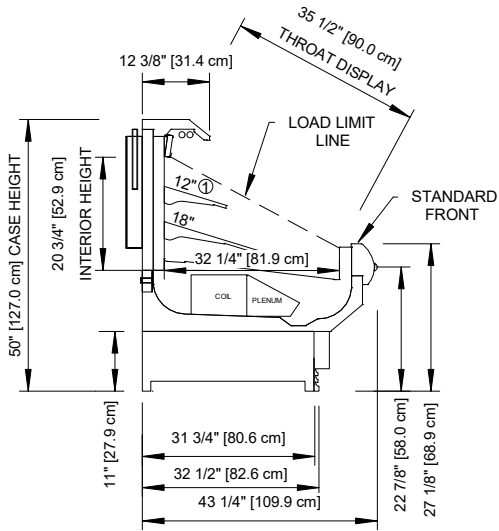

11" BASE FRAME

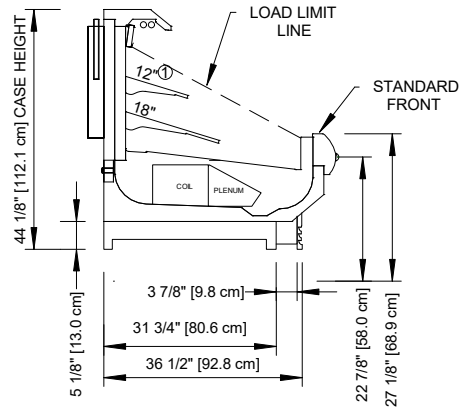

5" BASE FRAME

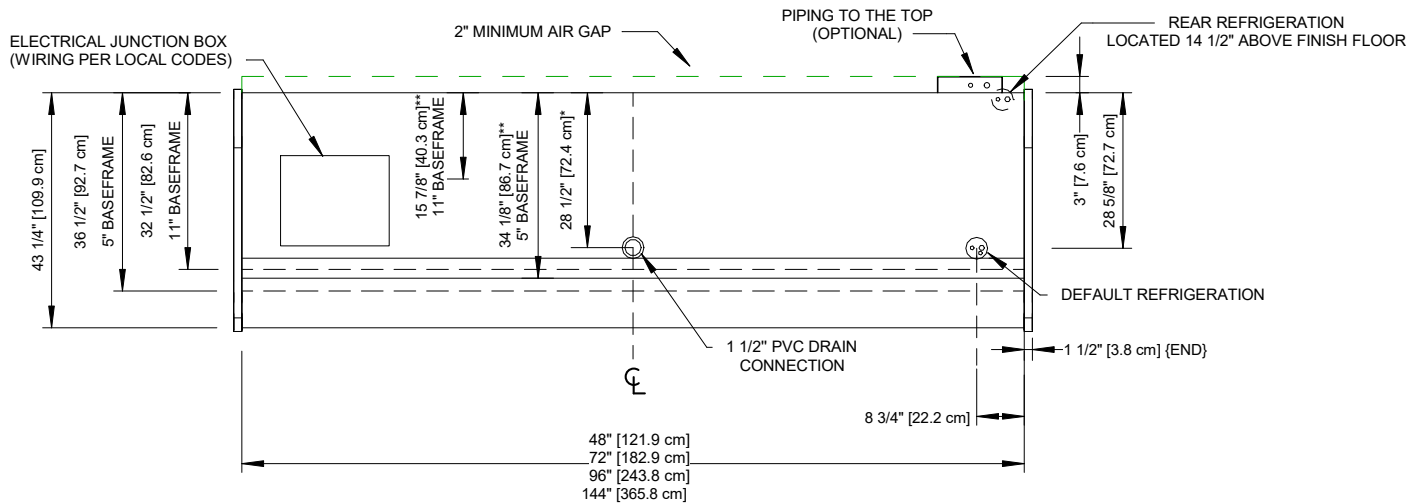

NOTES:

- * :STUB-UP AREA
 - ** :RECOMMENDED STUB-UP CENTERLINE FOR ELECTRICAL AND HUB DRAINS
 - ① :AVAILABLE SHELF SIZES ARE 10", 12", 14", 16", & 18"
- Ends add approximately 1 inch to case height, 1 inch to the front and 1/2 inch to the back
 - Product on top shelf should be 3 inches below discharge



O2.5UM-NRG

ALL MEASUREMENTS ARE TAKEN PER ASHRAE-72-2005 SPECIFICATIONS. HILLPHOENIX REFRIGERATED DISPLAY CASES FOR SALE IN THE UNITED STATES MEET OR EXCEED DEPARTMENT OF ENERGY 2017 REQUIREMENTS.

Rev Date:	Rev #	Revision Description:
9-10-18	3	DATA UPDATE
5-22-18	2	NEW STANDARDS

