

# O3.5UM-NRG

Medium Temp Unitized Island Merchandiser  
4', 6', 8', 12' Dairy/Deli/Meat/Produce

## GENERAL NOTES:

- "---" indicates that the feature is not an option for this case model and/or that the data is not yet available.
- LED lights only.
- Maximum of 3 rows of standard output LED lighted shelves.
- Nose lights are not available.

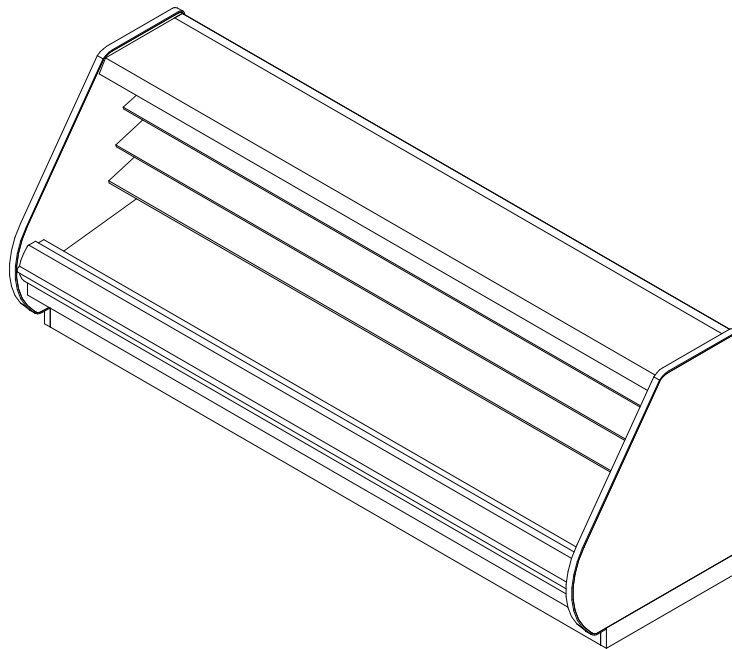

SHIPPING WEIGHT	
Case	Weight
O3.5UM-NRG	---



ALL MEASUREMENTS ARE TAKEN PER ASHRAE-72-2005 SPECIFICATIONS. HILLPHOENIX REFRIGERATED DISPLAY CASES FOR SALE IN THE UNITED STATES MEET OR EXCEED DEPARTMENT OF ENERGY 2017 REQUIREMENTS.

## O3.5UM-NRG

Rev. Date	Rev. #	Rev. Title
9-7-18	3	DATA UPDATE
5-15-18	2	NEW STANDARDS

**Hillphoenix**  
A DOVER COMPANY

# O3.5UM-NRG

Medium Temp Unitized Island Merchandiser  
4', 6', 8', 12' Dairy/Deli/Meat/Produce

ELECTRICAL DATA			
Case Length	Fans Per Case	High Efficiency Fans	
		120 Volts	
		Amps	Watts
4'	1	0.20	14.0
6'	2	0.40	28.0
8'	2	0.40	28.0
12'	3	0.60	42.0

LIGHTING DATA						
Case Length	Lights per row	Lights Length	Clearvoyant LED Lighting (Per Light Row)			
			Standard Power (Cornice or Shelf)		High Power (Cornice)	
			120 Volts		120 Volts	
			Amps	Watts	Amps	Watts
4'	1	4'	0.05	5.9	0.12	14.9
6'	2	3'	0.08	9.4	0.20	23.8
8'	2	4'	0.10	11.8	0.25	29.9
12'	3	4'	0.15	17.6	0.37	44.8

GUIDELINES AND CONTROL SETTINGS							
Application	Front Sill Height	BTUH/ft		Superheat Set Point @ Bulb (°F)	Evaporator (°F)	Discharge Air (°F)	Discharge Air Velocity (FPM)
		Conventional	Parallel				
Dairy/Deli/Produce	All	1063	930	6 - 8	28	31	150
Meat	Extended	1051	920	6 - 8	26	30	150

DEFROST CONTROLS		
Defrosts Per Day	Timed-Off Defrost	
	Fail-Safe (Min)	Termination Temp (°F)
6	30	47

## NOTES

- "---" indicates that feature is not an option with this case model and/or the data is not yet available.
- Listed BTUH/ft data represent unlighted shelves. For LED lighting, add 9 BTUH/ft per row of lighted shelving.
- BTUH load increases by 132 BTUH/ft when aftermarket merchandising accessories are utilized.
- Listed evaporator temperature represents unlighted shelves. For lighted shelves and/or aftermarket merchandising accessories, reduce the listed evaporator temperature by 2°F.
- Conventional Discharge Air Control – Recommended Settings: Cut-In Temp = Discharge Air + 2°F; Cut-Out Temp = Discharge Air - 2°F.
- Listed discharge air velocity represents the average velocity immediately after defrost.
- Temperature and defrost settings listed above are recommended start-up settings. Final operational settings may need to be adjusted for the store conditions in which the case operates.
- The recommended evaporator temperatures may need to be adjusted based on system setup, store conditions, etc. The minimum recommended evaporator temperature is 4°F below the listed evaporator temperature.



ALL MEASUREMENTS ARE TAKEN PER ASHRAE-72-2005 SPECIFICATIONS. HILLPHOENIX REFRIGERATED DISPLAY CASES FOR SALE IN THE UNITED STATES MEET OR EXCEED DEPARTMENT OF ENERGY 2017 REQUIREMENTS.

## O3.5UM-NRG

Rev. Date	Rev. #	Rev. Title
9-7-18	3	DATA UPDATE
5-15-18	2	NEW STANDARDS

**Hillphoenix**  
A DOVER COMPANY

# O3.5UM-NRG

Medium Temp Unitized Island Merchandiser  
4', 6', 8', 12' Dairy/Deli/Meat/Produce

SECOND NATURE DATA								
Case Model	No. of Coils	Application	Front Sill Type	BTUH/FT (DR)		GPM/ft (DR)	Supply Fluid Temp (°F)	Discharge Air Temp (°F)
				Conventional	Parallel			
O3.5UM-NRG	1	Bulk Produce	All Fronts	1063	930	0.12	20	37
O3.5UM-NRG	1	Deli/Produce	All Fronts	1063	930	0.27	20	31
O3.5UM-NRG	1	Meat	33" Front	1051	920	0.32	20	30
O3.5UM-NRG	1	Bulk Produce	All Fronts	1063	930	0.22	25	37
O3.5UM-NRG	1	Deli/Produce	All Fronts	1063	930	0.70	25	31
O3.5UM-NRG	1	Meat	33" Front	1051	920	0.97	25	30

SECOND NATURE DATA								
Case Model	No. of Coils	Application	Front Sill Type	No. of Defrost	Timed-Off Defrost		Warm Fluid Defrost	
					Fail Safe (Min)	Termination Temp (°F)	Fail Safe (Min)	Termination Temp (°F)
O3.5UM-NRG	1	Bulk Produce	All Fronts	6	60	47	26	49
O3.5UM-NRG	1	Deli/Produce	All Fronts	6	60	47	26	49
O3.5UM-NRG	1	Meat	33" Front	6	60	47	26	49
O3.5UM-NRG	1	Bulk Produce	All Fronts	6	45	42	26	49
O3.5UM-NRG	1	Deli/Produce	All Fronts	6	45	42	26	49
O3.5UM-NRG	1	Meat	33" Front	6	45	42	26	49



ALL MEASUREMENTS ARE TAKEN PER ASHRAE-72-2005 SPECIFICATIONS. HILLPHOENIX REFRIGERATED DISPLAY CASES FOR SALE IN THE UNITED STATES MEET OR EXCEED DEPARTMENT OF ENERGY 2017 REQUIREMENTS.







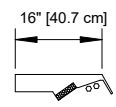

## O3.5UM-NRG

Rev. Date	Rev. #	Rev. Title
9-7-18	3	DATA UPDATE
5-15-18	2	NEW STANDARDS

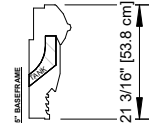
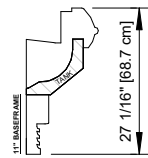
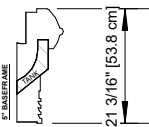
**Hillphoenix**  
A DOVER COMPANY

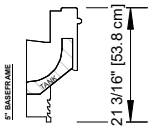
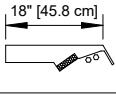
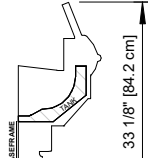
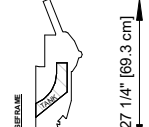
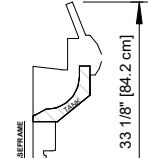
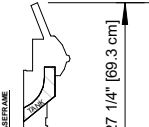
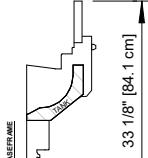
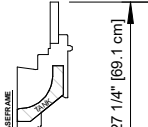
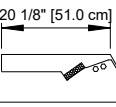
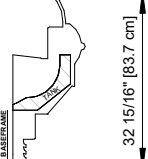
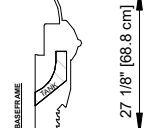
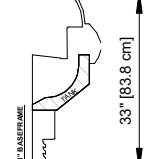
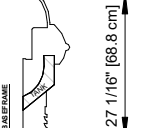
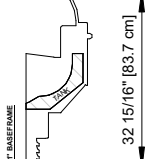
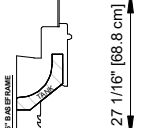
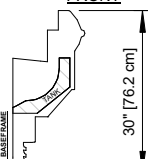
# O3.5UM-NRG

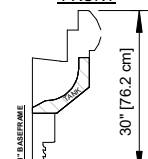
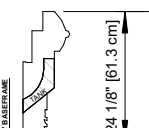
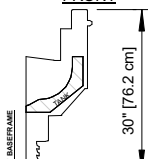
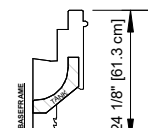
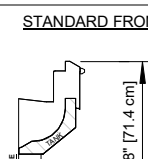
Medium Temp Unitized Island Merchandiser  
4', 6', 8', 12' Dairy/Deli/Meat/Produce

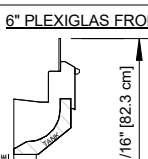
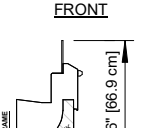
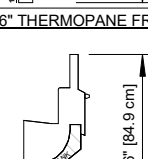
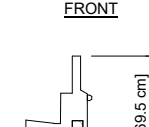
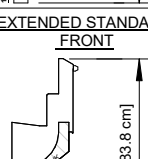
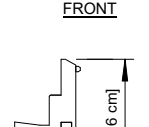
REAR SILL OPTIONS	FRONT OPTIONS					
	ORIGIN 2 FRONT				FLAT FRONT FLAT TOP	
	STANDARD FRONT	STANDARD FRONT	STANDARD FRONT	STANDARD FRONT	STANDARD FRONT	STANDARD FRONT
<b>16" REAR SILL (FRONT DISCHARGE)</b>  16" [40.7 cm]	 27 1/16" [68.7 cm]	 21 3/16" [53.8 cm]	 27 1/16" [68.7 cm]	 21 3/16" [53.8 cm]	 27 1/16" [68.7 cm]	 21 3/16" [53.8 cm]
<b>18" REAR SILL (FRONT DISCHARGE)</b>  18" [45.8 cm]	 33 1/8" [84.2 cm]	 27 1/4" [69.3 cm]	 33 1/8" [84.2 cm]	 27 1/4" [69.3 cm]	 33 1/8" [84.1 cm]	 27 1/4" [69.1 cm]
<b>20" REAR SILL (FRONT DISCHARGE)</b>  20 1/8" [51.0 cm]	 32 15/16" [83.7 cm]	 27 1/8" [68.8 cm]	 33" [83.8 cm]	 27 1/16" [68.8 cm]	 32 15/16" [83.7 cm]	 27 1/16" [68.8 cm]
	<b>EXTENDED STANDARD FRONT</b>  30" [76.2 cm]	<b>EXTENDED STANDARD FRONT</b>  24 3/16" [61.4 cm]	<b>EXTENDED STANDARD FRONT</b>  30" [76.2 cm]	<b>EXTENDED STANDARD FRONT</b>  24 1/8" [61.3 cm]	<b>EXTENDED STANDARD FRONT</b>  30" [76.2 cm]	<b>EXTENDED STANDARD FRONT</b>  24 1/8" [61.3 cm]
	<b>FLAT FRONT ANGLED TOP</b>					
	<b>STANDARD FRONT</b>  28 1/8" [71.4 cm]	<b>STANDARD FRONT</b>  22 5/16" [56.7 cm]	<b>6" PLEXIGLAS FRONT</b>  32 7/16" [82.3 cm]	<b>6" PLEXIGLAS FRONT</b>  26 5/16" [66.9 cm]		
	<b>6" THERMOPANE FRONT</b>  33 7/16" [84.9 cm]	<b>6" THERMOPANE FRONT</b>  27 3/8" [69.5 cm]	<b>EXTENDED STANDARD FRONT</b>  33" [83.8 cm]	<b>EXTENDED STANDARD FRONT</b>  27" [68.6 cm]		

**NOTES:**

- Front and rear sill height vary with base frame height.
- Extended front sills are required on meat applications to maintain proper product temperature. An extended front has a minimum height of 24" on a 5" base frame, or 30" on an 11" base frame.



ALL MEASUREMENTS ARE TAKEN PER ASHRAE-72-2005 SPECIFICATIONS. HILLPHOENIX REFRIGERATED DISPLAY CASES FOR SALE IN THE UNITED STATES MEET OR EXCEED DEPARTMENT OF ENERGY 2017 REQUIREMENTS.

**O3.5UM-NRG**

Rev. Date	Rev. #	Rev. Title
9-7-18	3	DATA UPDATE
5-15-18	2	NEW STANDARDS



A DOVER COMPANY

# O3.5UM-NRG

Medium Temp Unitized Island Merchandiser  
4', 6', 8', 12' Dairy/Deli/Meat/Produce

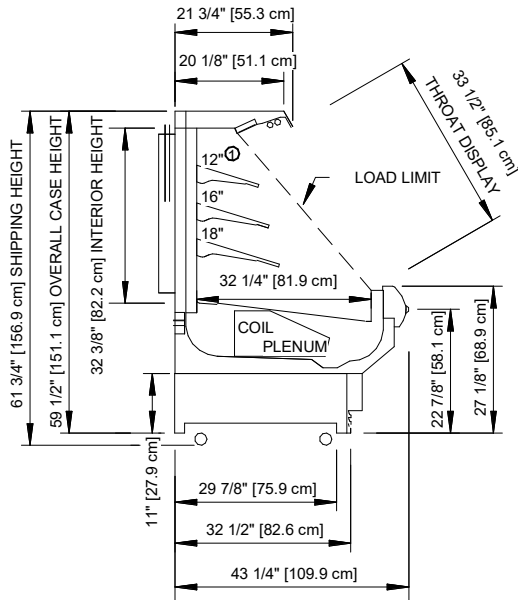

**11" BASE FRAME**

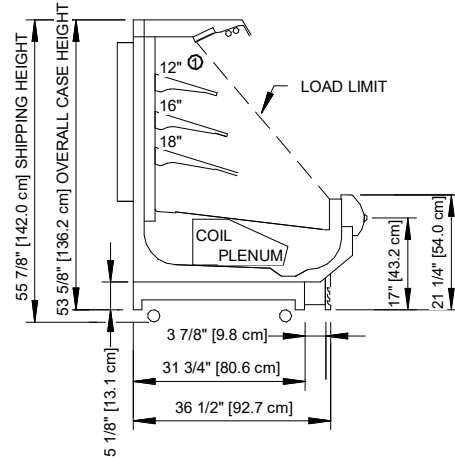

**5" BASE FRAME**

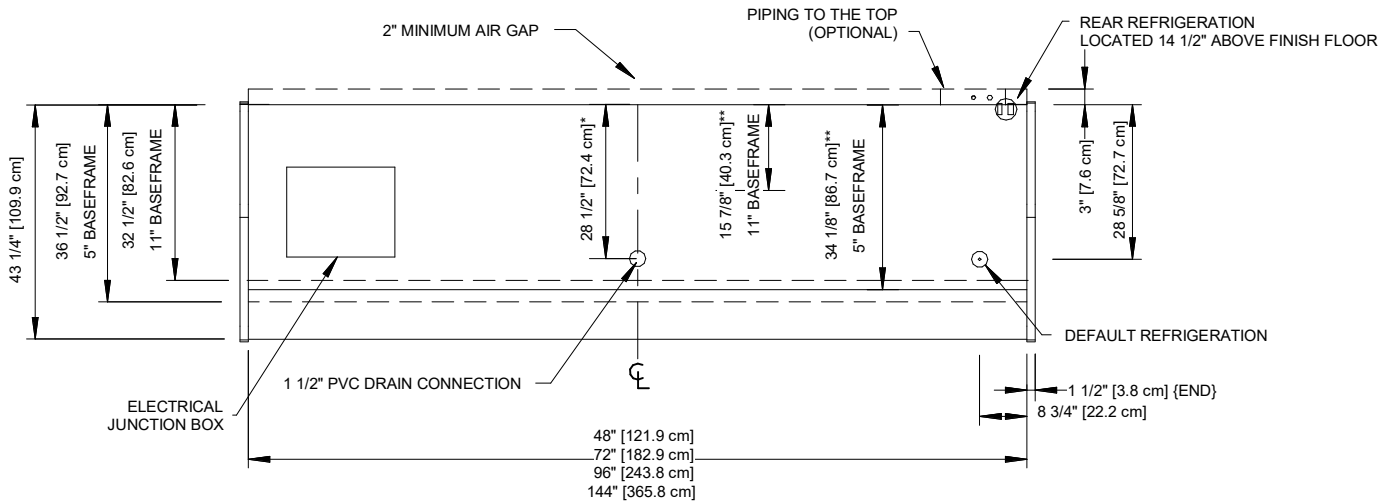

**NOTES**

- \* :STUB-UP AREA
- \*\* :RECOMMENDED STUB-UP CENTERLINE FOR ELECTRICAL AND HUB DRAINS
- ① :AVAILABLE SHELF SIZES ARE 10", 12", 14", 16" & 18"

- Ends add approximately 1" to case height, 1" to the front & 1/2" to the back.
- Product on top shelf should be 3" below discharge.
- Dashed lines signify area inside base rail behind kickplate.



**O3.5UM-NRG**

ALL MEASUREMENTS ARE TAKEN PER ASHRAE-72-2005 SPECIFICATIONS. HILLPHOENIX REFRIGERATED DISPLAY CASES FOR SALE IN THE UNITED STATES MEET OR EXCEED DEPARTMENT OF ENERGY 2017 REQUIREMENTS.

Rev. Date	Rev. #	Rev. Title
9-7-18	3	DATA UPDATE
5-15-18	2	NEW STANDARDS

