

O3UM-NRG

Multi-Deck Merchandiser with Synerg-E™
4', 6', 8', 10', 12' (Dairy/Deli/Meat/Produce)

GENERAL NOTES

- "---" indicates that the feature is not an option for this case model and/or the data is not yet available.
- LED lights only.
- Maximum of 2 rows of standard output LED lighted shelves.
- Nose lights are not available.

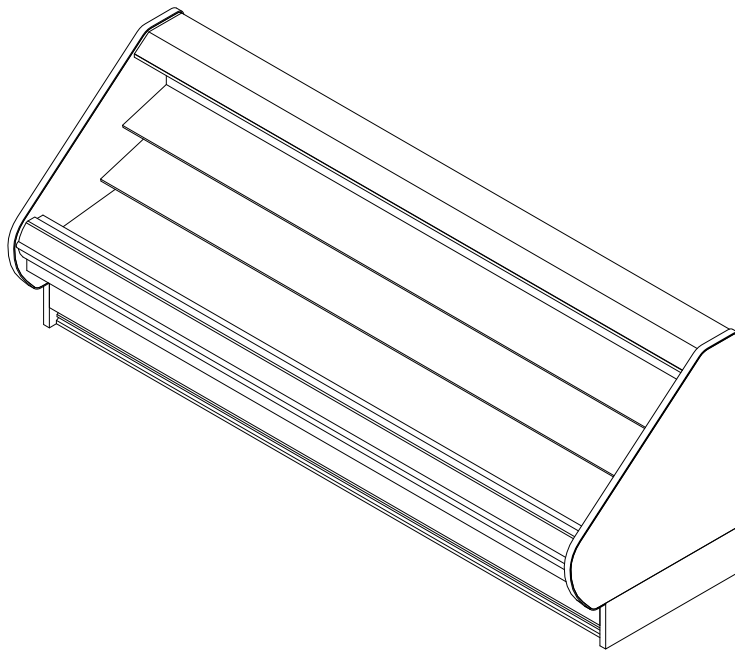

| SHIPPING WEIGHT | |
|-----------------|--------|
| Case | Weight |
| O3UM-NRG | --- |



ALL MEASUREMENTS ARE TAKEN PER ASHRAE-72-2005 SPECIFICATIONS. HILLPHOENIX REFRIGERATED DISPLAY CASES FOR SALE IN THE UNITED STATES MEET OR EXCEED DEPARTMENT OF ENERGY 2017 REQUIREMENTS.

O3UM-NRG

| Rev. Date | Rev. # | Rev. Title |
|-----------|--------|---------------|
| 9-10-18 | 3 | DATA UPDATE |
| 5-22-18 | 2 | NEW STANDARDS |

Hillphoenix
A DOVER COMPANY

O3UM-NRG

Multi-Deck Merchandiser with Synerg-E™
4', 6', 8', 10', 12' (Dairy/Deli/Meat/Produce)

| ELECTRICAL DATA | | | |
|-----------------|---------------|----------------------|-------|
| Case Length | Fans Per Case | High Efficiency Fans | |
| | | 120 Volts | |
| | | Amps | Watts |
| 4' | 1 | 0.16 | 11.0 |
| 6' | 2 | 0.32 | 22.0 |
| 8' | 2 | 0.32 | 22.0 |
| 10' | 3 | 0.48 | 33.0 |
| 12' | 3 | 0.48 | 33.0 |

| LIGHTING DATA | | | | | | |
|---------------|----------------|---------------|--|-------|----------------------|-------|
| Case Length | Lights per row | Lights Length | Clearvoyant LED Lighting (Per Light Row) | | | |
| | | | Standard Power (Cornice or Shelf) | | High Power (Cornice) | |
| | | | 120 Volts | | 120 Volts | |
| | | | Amps | Watts | Amps | Watts |
| 4' | 1 | 4' | 0.05 | 5.9 | 0.12 | 14.9 |
| 6' | 2 | 3' | 0.08 | 9.4 | 0.20 | 23.8 |
| 8' | 2 | 4' | 0.10 | 11.8 | 0.25 | 29.9 |
| 10' | 3 | 3 3/4' | 0.13 | 15.3 | 0.32 | 38.7 |
| 12' | 3 | 4' | 0.15 | 17.6 | 0.37 | 44.8 |

| GUIDELINES AND CONTROL SETTINGS | | | | | | | |
|---------------------------------|-------------------|--------------|----------|---------------------------------|-----------------|--------------------|------------------------------|
| Application | Front Sill Height | BTUH/ft | | Superheat Set Point @ Bulb (°F) | Evaporator (°F) | Discharge Air (°F) | Discharge Air Velocity (FPM) |
| | | Conventional | Parallel | | | | |
| Dairy/Deli/Produce | All | 830 | 770 | 6 - 8 | 28 | 31 | 180 |
| Meat | Extended | 830 | 750 | 6 - 8 | 26 | 30 | 180 |

| DEFROST CONTROLS | | |
|------------------|-------------------|-----------------------|
| Defrosts Per Day | Timed-Off Defrost | |
| | Fail-Safe (Min) | Termination Temp (°F) |
| 6 | 30 | 47 |

NOTES

- "---" indicates that the feature is not an option for this case model and/or the data is not yet available.
- Listed BTUH/ft data represent unlighted shelves. For LED lighting, add 9 BTUH/ft per row of lighted shelving. BTUH load increases by 132 BTUH/ft when aftermarket merchandising accessories are utilized.
- Listed evaporator temperature represents unlighted shelves. For lighted shelves and/or aftermarket merchandising accessories, reduce the listed evaporator temperature by 2°F.
- Conventional Discharge Air Control – Recommended Settings: Cut-In Temp = Discharge Air + 2°F; Cut-Out Temp = Discharge Air - 2°F.
- Listed discharge air velocity represents the average velocity immediately after defrost.
- Temperature and defrost settings listed above are recommended start-up settings. Final operational settings may need to be adjusted for the store conditions in which the case operates.
- The recommended evaporator temperatures may need to be adjusted based on system setup, store conditions, etc. The minimum recommended evaporator temperature is 4°F below the listed evaporator temperature.



ALL MEASUREMENTS ARE TAKEN PER ASHRAE-72-2005 SPECIFICATIONS. HILLPHOENIX REFRIGERATED DISPLAY CASES FOR SALE IN THE UNITED STATES MEET OR EXCEED DEPARTMENT OF ENERGY 2017 REQUIREMENTS.

O3UM-NRG

| Rev. Date | Rev. # | Rev. Title |
|-----------|--------|---------------|
| 9-10-18 | 3 | DATA UPDATE |
| 5-22-18 | 2 | NEW STANDARDS |

Hillphoenix
A DOVER COMPANY

O3UM-NRG

Multi-Deck Merchandiser with Synerg-E™
4', 6', 8', 10', 12' (Dairy/Deli/Meat/Produce)

| SECOND NATURE DATA | | | | | | | | |
|--------------------|--------------|--------------|-----------------|--------------|----------|-------------|------------------------|-------------------------|
| Case Model | No. of Coils | Application | Front Sill Type | BTUH/FT (DR) | | GPM/ft (DR) | Supply Fluid Temp (°F) | Discharge Air Temp (°F) |
| | | | | Conventional | Parallel | | | |
| O3UM-NRG | 1 | Bulk Produce | Standard | 926 | 810 | 0.11 | 20 | 38 |
| O3UM-NRG | 1 | Deli/Produce | Standard | 926 | 810 | 0.23 | 20 | 31 |
| O3UM-NRG | 1 | Meat | 3" Extended | 915 | 800 | 0.28 | 20 | 30 |
| O3UM-NRG | 1 | Bulk Produce | Standard | 926 | 810 | 0.19 | 25 | 38 |
| O3UM-NRG | 1 | Deli/Produce | Standard | 926 | 810 | 0.60 | 25 | 31 |
| O3UM-NRG | 1 | Meat | 3" Extended | 915 | 800 | 0.83 | 25 | 30 |

| SECOND NATURE DATA | | | | | | | | |
|--------------------|--------------|--------------|-----------------|----------------|-------------------|-----------------------|--------------------|-----------------------|
| Case Model | No. of Coils | Application | Front Sill Type | No. of Defrost | Timed-Off Defrost | | Warm Fluid Defrost | |
| | | | | | Fail Safe (Min) | Termination Temp (°F) | Fail Safe (Min) | Termination Temp (°F) |
| O3UM-NRG | 1 | Bulk Produce | Standard | 6 | 60 | 47 | 26 | 49 |
| O3UM-NRG | 1 | Deli/Produce | Standard | 6 | 60 | 47 | 26 | 49 |
| O3UM-NRG | 1 | Meat | 3" Extended | 6 | 60 | 47 | 26 | 49 |
| O3UM-NRG | 1 | Bulk Produce | Standard | 6 | 45 | 42 | 26 | 49 |
| O3UM-NRG | 1 | Deli/Produce | Standard | 6 | 45 | 42 | 26 | 49 |
| O3UM-NRG | 1 | Meat | 3" Extended | 6 | 45 | 42 | 26 | 49 |



ALL MEASUREMENTS ARE TAKEN PER ASHRAE-72-2005 SPECIFICATIONS. HILLPHOENIX REFRIGERATED DISPLAY CASES FOR SALE IN THE UNITED STATES MEET OR EXCEED DEPARTMENT OF ENERGY 2017 REQUIREMENTS.

O3UM-NRG

| Rev. Date | Rev. # | Rev. Title |
|-----------|--------|---------------|
| 9-10-18 | 3 | DATA UPDATE |
| 5-22-18 | 2 | NEW STANDARDS |

Hillphoenix
A DOVER COMPANY

O3UM-NRG

Multi-Deck Merchandiser with Synerg-E™
4', 6', 8', 10', 12' (Dairy/Deli/Meat/Produce)

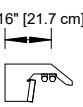
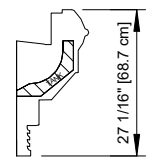
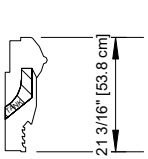
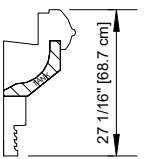
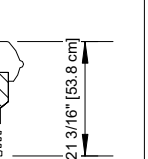
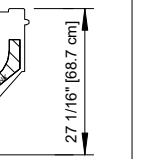
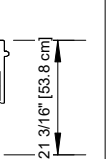
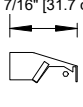
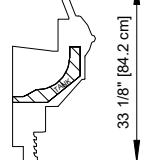
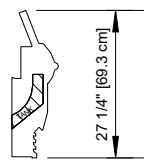
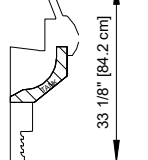
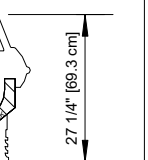
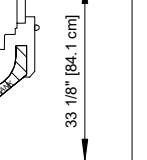
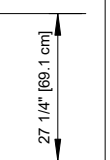
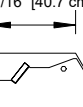
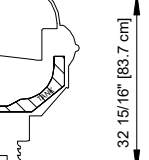
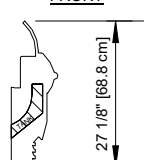
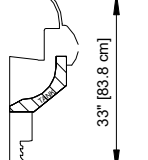
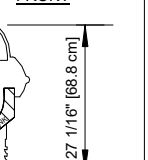
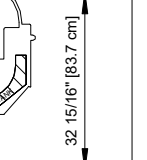
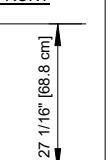
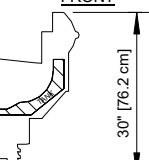
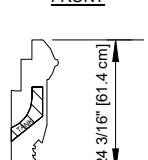
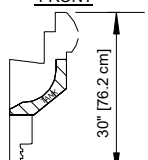
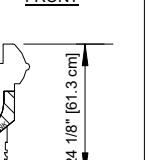
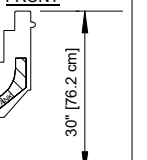
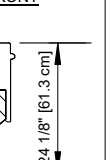
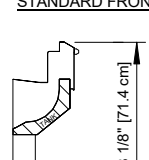
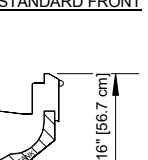
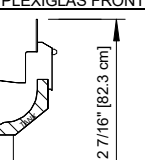
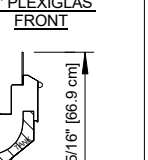
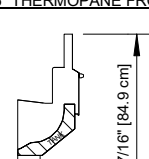
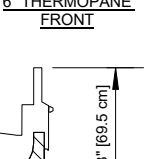
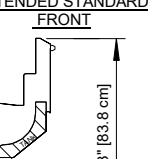
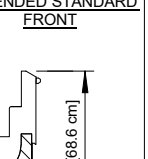
| REAR SILL OPTIONS | FRONT OPTIONS | | | | | |
|--|--|--|---|--|--|--|
| | ORIGIN 2 FRONT | | | | FLAT FRONT FLAT TOP | |
| | STANDARD FRONT | STANDARD FRONT | STANDARD FRONT | STANDARD FRONT | STANDARD FRONT | STANDARD FRONT |
| STANDARD REAR SILL  8 9/16" [21.7 cm] |  |  |  |  |  |  |
| 12 1/2" REAR SILL  12 7/16" [31.7 cm] |  |  |  |  |  |  |
| 16" REAR SILL (REAR DISCHARGE)  16 1/16" [40.7 cm] |  |  |  |  |  |  |
| | EXTENDED STANDARD FRONT  | EXTENDED STANDARD FRONT  | EXTENDED STANDARD FRONT  | EXTENDED STANDARD FRONT  | EXTENDED STANDARD FRONT  | EXTENDED STANDARD FRONT  |
| | FLAT FRONT ANGLED TOP | | | | | |
| | STANDARD FRONT  | STANDARD FRONT  | 6" PLEXIGLAS FRONT  | 6" PLEXIGLAS FRONT  | | |
| | 6" THERMOPANE FRONT  | 6" THERMOPANE FRONT  | EXTENDED STANDARD FRONT  | EXTENDED STANDARD FRONT  | | |

NOTES:

- Front and rear sill heights vary with base frame height.
- Extended front sills are required for meat applications to maintain proper product temperature. An extended front has a minimum height of 24" on a 5" baseframe, or 30" on an 11" baseframe.



ALL MEASUREMENTS ARE TAKEN PER ASHRAE-72-2005 SPECIFICATIONS. HILLPHOENIX REFRIGERATED DISPLAY CASES FOR SALE IN THE UNITED STATES MEET OR EXCEED DEPARTMENT OF ENERGY 2017 REQUIREMENTS.

O3UM-NRG

| Rev. Date | Rev. # | Rev. Title |
|-----------|--------|---------------|
| 9-10-18 | 3 | DATA UPDATE |
| 5-22-18 | 2 | NEW STANDARDS |



O3UM-NRG

Multi-Deck Merchandiser with Synerg-E™
4', 6', 8', 10', 12' (Dairy/Deli/Meat/Produce)

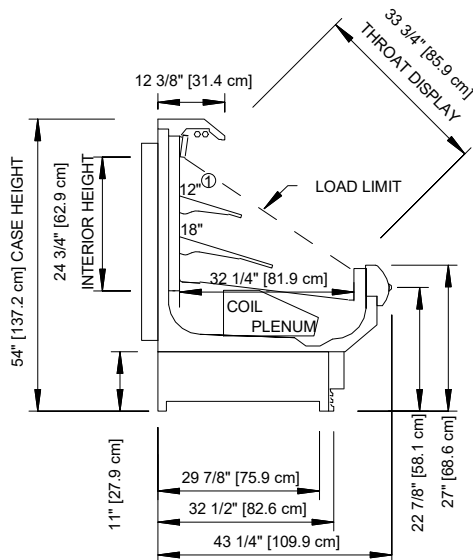

11" BASE FRAME

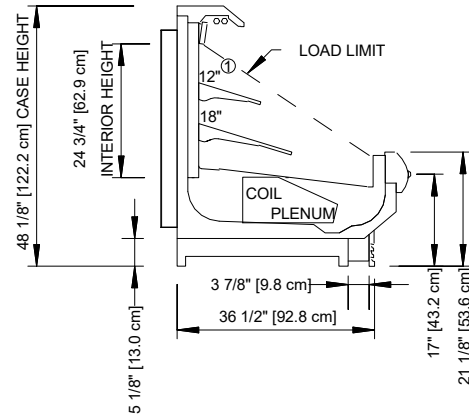

5" BASE FRAME

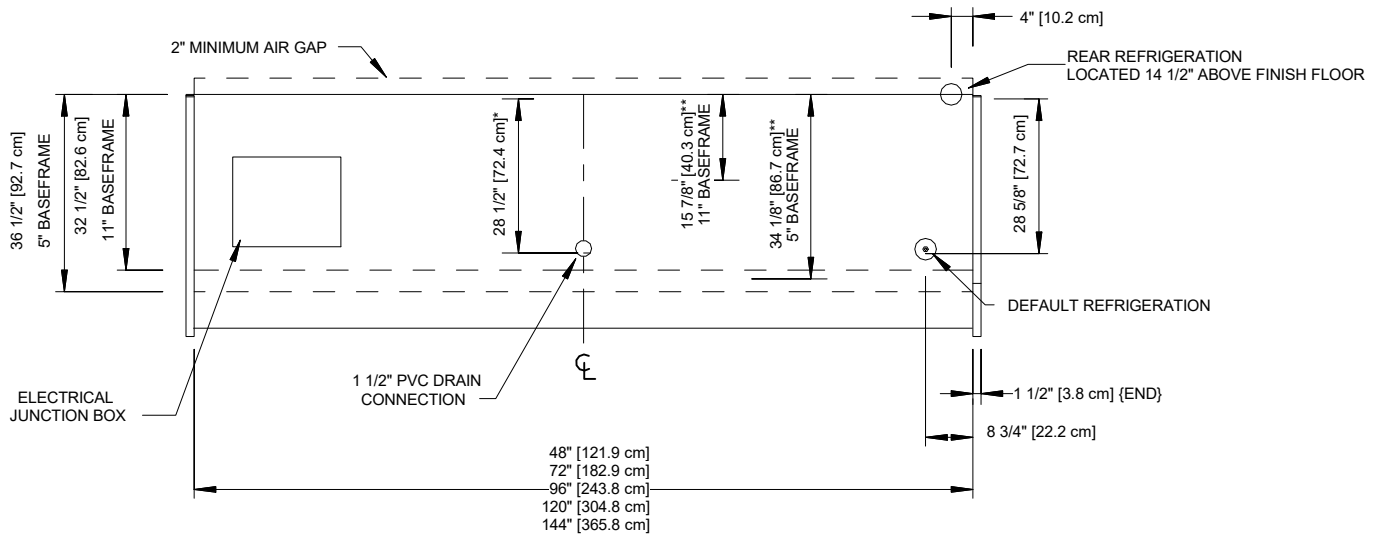

NOTES

- * :STUB-UP AREA
- ** :RECOMMENDED STUB-UP CENTERLINE FOR ELECTRICAL AND HUB DRAINS
- ① :AVAILABLE SHELF SIZES: 10", 12", 14", 16", & 18"

• Ends add approximately 1" to case height, 1" to the front and 1/2" to the back.



ALL MEASUREMENTS ARE TAKEN PER ASHRAE-72-2005 SPECIFICATIONS. HILLPHOENIX REFRIGERATED DISPLAY CASES FOR SALE IN THE UNITED STATES MEET OR EXCEED DEPARTMENT OF ENERGY 2017 REQUIREMENTS.

O3UM-NRG

| Rev. Date | Rev. # | Rev. Title |
|-----------|--------|---------------|
| 9-10-18 | 3 | DATA UPDATE |
| 5-22-18 | 2 | NEW STANDARDS |

