

# O5DM-NRG

Multi-Deck Merchandiser with Synerg-E™  
4', 6', 8' & 12' (Beverage / Dairy / Deli / Produce)

**GENERAL NOTES:**

- "---" indicates that the feature is not an option on this case model and/or the data is not available at this time.
- If the O5DM-NRG case is being lined up to an ORS5DM reach-in case, a 21" front is recommended on the O5DM-NRG for best appearances.
- LED lights only.
- Maximum of 5 rows of Standard Output LED lighted shelves.

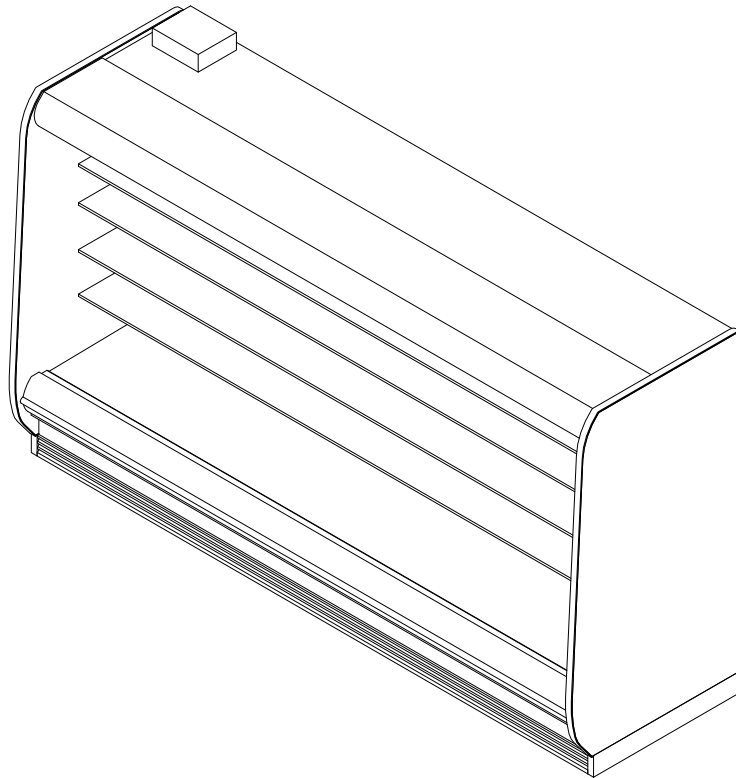

SHIPPING WEIGHT	
Case	Weight
O5DM-NRG	---



ALL MEASUREMENTS ARE TAKEN PER ASHRAE-72-2005 SPECIFICATIONS. HILLPHOENIX REFRIGERATED DISPLAY CASES FOR SALE IN THE UNITED STATES MEET OR EXCEED DEPARTMENT OF ENERGY 2017 REQUIREMENTS.

**O5DM-NRG**

Rev. Date	Rev. #	Rev. Title
1-31-19	4	ENDVIEW UPDATE
9-11-18	3	DATA UPDATE



# O5DM-NRG

Multi-Deck Merchandiser with Synerg-E™  
4', 6', 8' & 12' (Beverage / Dairy / Deli / Produce)

ELECTRICAL DATA			
Case Length	Fans Per Case	High Efficiency Fans	
		120 Volt	
		Amps	Watts
4'	1	0.23	18.0
6'	2	0.47	35.0
8'	2	0.47	35.0
12'	3	0.70	53.0

LIGHTING DATA					
Case Length	Lights per row	Clearvoyant v4 LED Lighting (Per Light Row)			
		Standard Power (Cornice or Shelf)		High Power (Cornice Only)	
		120 Volts		120 Volts	
		Amps	Watts	Amps	Watts
4'	1	0.05	5.9	0.12	14.9
6'	2	0.08	9.4	0.20	23.8
8'	2	0.10	11.8	0.25	29.9
12'	3	0.15	17.6	0.37	44.8

GUIDELINES AND CONTROL SETTINGS							
Application	Front Sill height	BTUH/ft		Superheat Set Point @ Bulb (°F)	Evaporator (°F)	Discharge Air (°F)	Discharge Air Velocity (FPM)
		Conventional	Parallel				
Beverage/Bulk Produce	7.5" Extended	1023	895	6 - 8	34	37	140
Beverage/Bulk Produce	5" Extended	994	870	6 - 8	34	37	140
Beverage/Bulk Produce	2.5" Extended	972	850	6 - 8	34	37	140
Beverage/Bulk Produce	Std. Dairy	1062	930	6 - 8	34	37	140
Dairy/Deli/Cut Produce	7.5" Extended	1263	1105	6 - 8	28	31	140
Dairy/Deli/Cut Produce	5" Extended	1234	1080	6 - 8	28	31	140
Dairy/Deli/Cut Produce	2.5" Extended	1211	1060	6 - 8	28	31	140
Dairy/Deli/Cut Produce	Std. Dairy	1303	1140	6 - 8	28	31	140

DEFROST CONTROLS			
Application	Defrosts Per Day	Timed-Off Defrost	
		Fail-Safe (Min)	Termination Temp (F)
Beverage/Bulk Produce	2	30	47
Dairy/Deli/Cut Produce	6	40	47

## NOTES:

- "---" indicates that the feature is not an option for this model.
- Listed BTUH/ft data represent unlighted shelves. For LED lighting, add 9 BTUH/ft per row of lighted shelving.
- BTUH load increases by 132 BTUH/ft when aftermarket merchandising accessories are utilized.
- Listed evaporator temperature represents unlighted shelves. For lighted shelves and/or aftermarket merchandising accessories, reduce the listed evaporator temperature by 2°F.
- Conventional Discharge Air Control – Recommended Settings: Cut-In Temp = Discharge Air + 2°F; Cut-Out Temp = Discharge Air - 2°F.
- Listed discharge air velocity represents the average velocity immediately after defrost.
- Temperature and defrost settings listed above are recommended start-up settings. Final operational settings may need to be adjusted for the store conditions in which the case operates.
- The recommended evaporator temperatures may need to be adjusted based on system setup, store conditions, etc. The minimum recommended evaporator temperature is 4°F below the listed evaporator temperature.



ALL MEASUREMENTS ARE TAKEN PER ASHRAE-72-2005 SPECIFICATIONS. HILLPHOENIX REFRIGERATED DISPLAY CASES FOR SALE IN THE UNITED STATES MEET OR EXCEED DEPARTMENT OF ENERGY 2017 REQUIREMENTS.

## O5DM-NRG

Rev. Date	Rev. #	Rev. Title
1-31-19	4	ENDVIEW UPDATE
9-11-18	3	DATA UPDATE

**Hillphoenix**  
A DOVER COMPANY

# O5DM-NRG

Multi-Deck Merchandiser with Synerg-E™  
4', 6', 8' & 12' (Beverage / Dairy / Deli / Produce)

## SECOND NATURE DATA

Case Model	No. of Coils	Application	Front Sill Type	BTUH/ft (DR)		GPM/ft (DR)	Supply Fluid Temp (F)	Discharge Air Temp (F)
				Conventional	Parallel			
O5DM-NRG	1	Beverage/Bulk Produce	7.5" Extended	972	850	0.11	20	37
O5DM-NRG	1	Beverage/Bulk Produce	5" Extended	994	870	0.12	20	37
O5DM-NRG	1	Beverage/Bulk Produce	2.5" Extended	1023	895	0.12	20	37
O5DM-NRG	1	Beverage/Bulk Produce	Std. Dairy	1062	930	0.12	20	37
O5DM-NRG	1	Dairy/Deli/Cut Produce	7.5" Extended	1211	1060	0.31	20	31
O5DM-NRG	1	Dairy/Deli/Cut Produce	5" Extended	1234	1080	0.32	20	31
O5DM-NRG	1	Dairy/Deli/Cut Produce	2.5" Extended	1263	1105	0.32	20	31
O5DM-NRG	1	Dairy/Deli/Cut Produce	Std. Dairy	1303	1140	0.33	20	31
O5DM-NRG	1	Beverage/Bulk Produce	7.5" Extended	972	850	0.21	25	37
O5DM-NRG	1	Beverage/Bulk Produce	5" Extended	994	870	0.21	25	37
O5DM-NRG	1	Beverage/Bulk Produce	2.5" Extended	1023	895	0.22	25	37
O5DM-NRG	1	Beverage/Bulk Produce	Std. Dairy	1062	930	0.23	25	37
O5DM-NRG	1	Dairy/Deli/Cut Produce	7.5" Extended	1211	1060	0.56	25	31
O5DM-NRG	1	Dairy/Deli/Cut Produce	5" Extended	1234	1080	0.57	25	31
O5DM-NRG	1	Dairy/Deli/Cut Produce	2.5" Extended	1263	1105	0.58	25	31
O5DM-NRG	1	Dairy/Deli/Cut Produce	Std. Dairy	1303	1140	0.60	25	31

## SECOND NATURE DATA

Case Model	No. of Coils	Application	Front Sill Type	No. of Defrost	Timed Off Defrost		Warm Fluid Defrost	
					Fail Safe (Min)	Termination Temp (F)	Fail Safe (Min)	Termination Temp (F)
O5DM-NRG	1	Beverage/Bulk Produce	7.5" Extended	6	60	47	26	49
O5DM-NRG	1	Beverage/Bulk Produce	5" Extended	6	60	47	26	49
O5DM-NRG	1	Beverage/Bulk Produce	2.5" Extended	6	60	47	26	49
O5DM-NRG	1	Beverage/Bulk Produce	Std. Dairy	6	60	47	26	49
O5DM-NRG	1	Beverage/Bulk Produce	7.5" Extended	6	45	47	26	49
O5DM-NRG	1	Beverage/Bulk Produce	5" Extended	6	45	47	26	49
O5DM-NRG	1	Beverage/Bulk Produce	2.5" Extended	6	45	47	26	49
O5DM-NRG	1	Beverage/Bulk Produce	Std. Dairy	6	45	47	26	49
O5DM-NRG	1	Dairy/Deli/Cut Produce	7.5" Extended	6	60	47	26	49
O5DM-NRG	1	Dairy/Deli/Cut Produce	5" Extended	6	60	47	26	49
O5DM-NRG	1	Dairy/Deli/Cut Produce	2.5" Extended	6	60	47	26	49
O5DM-NRG	1	Dairy/Deli/Cut Produce	Std. Dairy	6	60	47	26	49
O5DM-NRG	1	Dairy/Deli/Cut Produce	7.5" Extended	6	45	47	26	49
O5DM-NRG	1	Dairy/Deli/Cut Produce	5" Extended	6	45	47	26	49
O5DM-NRG	1	Dairy/Deli/Cut Produce	2.5" Extended	6	45	47	26	49
O5DM-NRG	1	Dairy/Deli/Cut Produce	Std. Dairy	6	45	47	26	49



COMPONENT

ALL MEASUREMENTS ARE TAKEN PER ASHRAE-72-2005 SPECIFICATIONS. HILLPHOENIX REFRIGERATED DISPLAY CASES FOR SALE IN THE UNITED STATES MEET OR EXCEED DEPARTMENT OF ENERGY 2017 REQUIREMENTS.

## O5DM-NRG

Rev. Date	Rev. #	Rev. Title
1-31-19	4	ENDVIEW UPDATE
9-11-18	3	DATA UPDATE

**Hillphoenix**  
A DIVERSITY COMPANY

# O5DM-NRG

Multi-Deck Merchandiser with Synerg-E™  
4', 6', 8' & 12' (Beverage / Dairy / Deli / Produce)

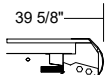
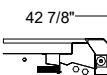
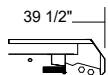
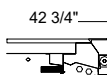
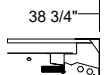
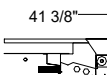
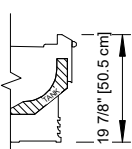
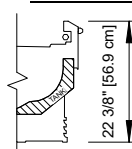
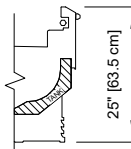
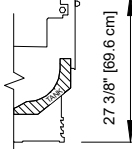
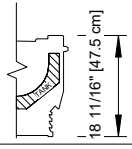
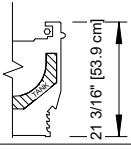
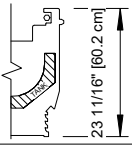
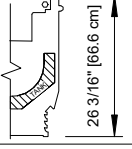
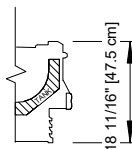
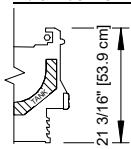
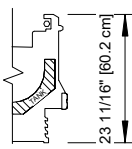
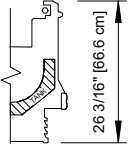
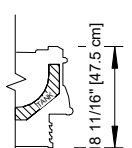
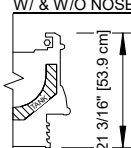
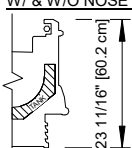
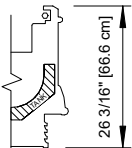
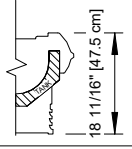
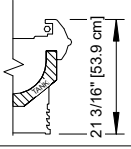
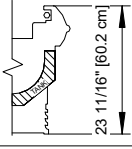
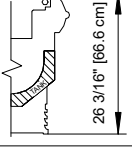
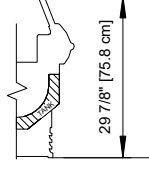
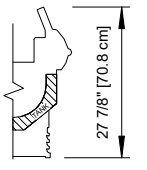
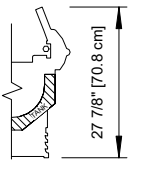
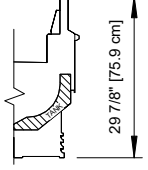
CORNICHE OPTIONS	CORNICHE OPTIONS					
	CURVED CORNICHE	CURVED CORNICHE WITH NIGHT COVER	FACETED CORNICHE	FACETED CORNICHE WITH NIGHT COVER	FLAT CORNICHE	FLAT CORNICHE WITH STANDARD NIGHT COVER
FRONT OPTIONS	 39 5/8"	 42 7/8"	 39 1/2"	 42 3/4"	 38 3/4"	 41 3/8"
	<u>FLAT FRONT 2</u> STANDARD FRONT  19 7/8" [50.5 cm]	<u>2 1/2" EXTENDED FRONT W/ &amp; W/O NOSE LIGHT</u>  22 3/8" [56.9 cm]	<u>5" EXTENDED FRONT W/ &amp; W/O NOSE LIGHT</u>  25" [63.5 cm]	<u>7 1/2" EXTENDED FRONT</u>  27 3/8" [69.6 cm]		
	<u>FLAT FRONT</u> STANDARD FRONT  18 11/16" [47.5 cm]	<u>2 1/2" EXTENDED FRONT W/ &amp; W/O NOSE LIGHT</u>  21 3/16" [53.9 cm]	<u>5" EXTENDED FRONT W/ &amp; W/O NOSE LIGHT</u>  23 11/16" [60.2 cm]	<u>7 1/2" EXTENDED FRONT</u>  26 3/16" [66.6 cm]		
	<u>CLASSIC 2 METAL</u> STANDARD FRONT  18 11/16" [47.5 cm]	<u>2 1/2" EXTENDED FRONT W/ &amp; W/O NOSE LIGHT</u>  21 3/16" [53.9 cm]	<u>5" EXTENDED FRONT W/ &amp; W/O NOSE LIGHT</u>  23 11/16" [60.2 cm]	<u>7 1/2" EXTENDED FRONT</u>  26 3/16" [66.6 cm]		
	<u>CLASSIC 2 POLYMER</u> STANDARD FRONT  18 11/16" [47.5 cm]	<u>2 1/2" EXTENDED FRONT W/ &amp; W/O NOSE LIGHT</u>  21 3/16" [53.9 cm]	<u>5" EXTENDED FRONT W/ &amp; W/O NOSE LIGHT</u>  23 11/16" [60.2 cm]	<u>7 1/2" EXTENDED FRONT</u>  26 3/16" [66.6 cm]		
	<u>ORIGIN 2</u> STANDARD FRONT  18 11/16" [47.5 cm]	<u>2 1/2" EXTENDED FRONT W/ &amp; W/O NOSE LIGHT</u>  21 3/16" [53.9 cm]	<u>5" EXTENDED FRONT W/ &amp; W/O NOSE LIGHT</u>  23 11/16" [60.2 cm]	<u>7 1/2" EXTENDED FRONT</u>  26 3/16" [66.6 cm]		
<u>THERMOPANE</u> 6" THERMOPANE FRONT  29 7/8" [75.8 cm]	4" THERMOPANE FRONT  27 7/8" [70.8 cm]	4" THERMOPANE FRONT W/T NOSE LIGHT  27 7/8" [70.8 cm]	6" THERMOPANE FRONT  29 7/8" [75.9 cm]			



COMPONENT

ALL MEASUREMENTS ARE TAKEN PER ASHRAE-72-2005 SPECIFICATIONS. HILLPHOENIX REFRIGERATED DISPLAY CASES FOR SALE IN THE UNITED STATES MEET OR EXCEED DEPARTMENT OF ENERGY 2017 REQUIREMENTS.

## O5DM-NRG

Rev. Date	Rev. #	Rev. Title
1-31-19	4	ENDVIEW UPDATE
9-11-18	3	DATA UPDATE

**Hillphoenix**  
A DOVER COMPANY

# O5DM-NRG

Multi-Deck Merchandiser with Synerg-E™  
4', 6', 8' & 12' (Beverage / Dairy / Deli / Produce)

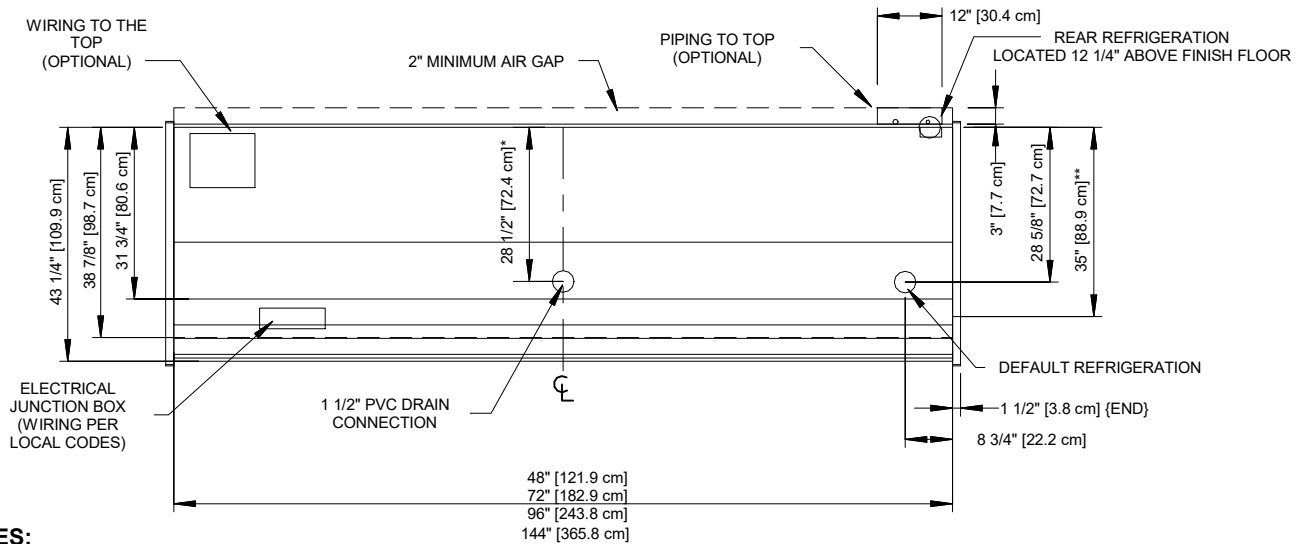
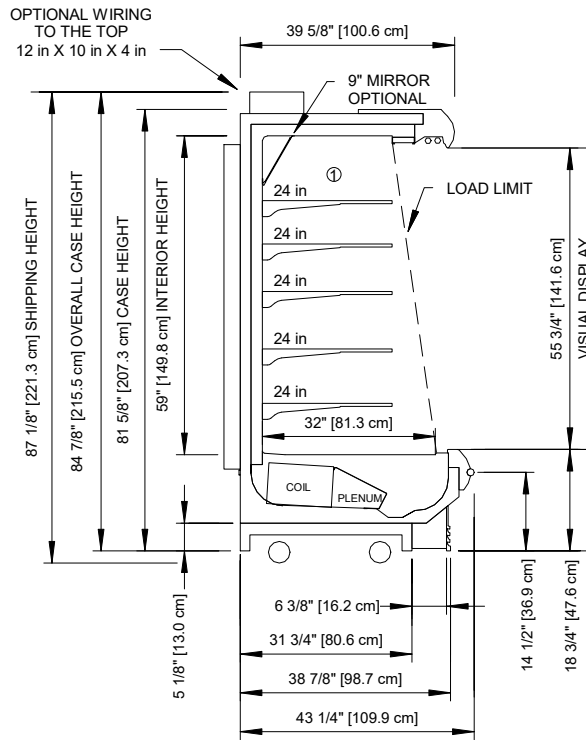

**NOTES:**

- \* : STUB-UP AREA
- \*\* : RECOMMENDED STUB-UP CENTERLINE FOR ELECTRICAL AND DRAINS
- ⊙ : AVAILABLE SHELF SIZES: 10", 12", 14", 16", 18", 20", 22" & 24"

- Ends add approximately 1" to case height, 1/2" to the back of the case and 1" to the front of the case.
- Back panels add approximately 1" to the rear of the case.



**O5DM-NRG**

ALL MEASUREMENTS ARE TAKEN PER ASHRAE-72-2005 SPECIFICATIONS. HILLPHOENIX REFRIGERATED DISPLAY CASES FOR SALE IN THE UNITED STATES MEET OR EXCEED DEPARTMENT OF ENERGY 2017 REQUIREMENTS.

Rev. Date	Rev. #	Rev. Title
1-31-19	4	ENDVIEW UPDATE
9-11-18	3	DATA UPDATE

