

O5MH-NRG

High Multi-Deck Merchandiser with Synerg-E™
4', 6', 8' & 12' (Deli / Meat)

GENERAL NOTES

- "---" indicates that the feature is not an option on this case model and/or the data is not available at this time.
- LED lights only.
- Maximum of 5 rows of Standard Output LED lighted shelves.

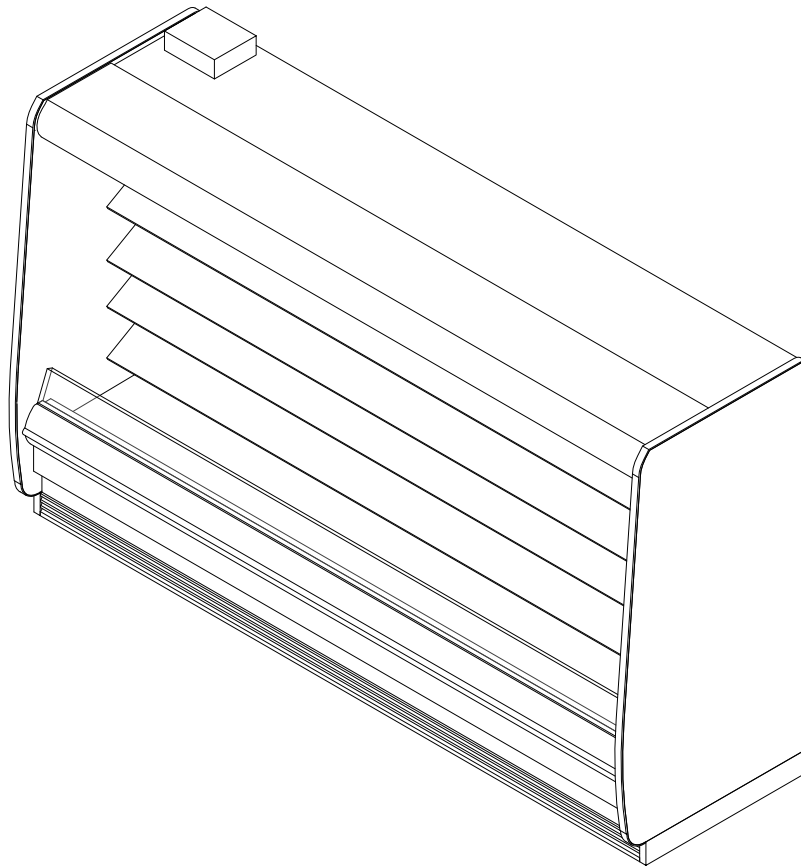

SHIPPING WEIGHT	
Case	Weight
O5MH-NRG	---



COMPONENT

ALL MEASUREMENTS ARE TAKEN PER ASHRAE-72-2005 SPECIFICATIONS. HILLPHOENIX REFRIGERATED DISPLAY CASES FOR SALE IN THE UNITED STATES MEET OR EXCEED DEPARTMENT OF ENERGY 2017 REQUIREMENTS.

O5MH-NRG

Rev Date:	Rev #	Revision Description:
10-16-18	4	PLEXIGLASS DEFLECTOR
9-28-18	3	DATA UPDATE

Hillphoenix
A DOVER COMPANY

ELECTRICAL DATA			
Case Length	Fans Per Case	High Efficiency Fans	
		120 Volt	
		Amps	Watts
4'	2	0.46	36.0
6'	4	0.94	70.0
8'	4	0.94	70.0
12'	6	1.40	106.0

LIGHTING DATA					
Case Length	Lights per row	Clearvoyant v4 LED Lighting (Per Light Row)			
		Standard Power (Cornice or Shelf)		High Power (Cornice Only)	
		120 Volts		120 Volts	
		Amps	Watts	Amps	Watts
4'	1	0.05	5.9	0.12	14.9
6'	2	0.08	9.4	0.20	23.8
8'	2	0.10	11.8	0.25	29.9
12'	3	0.15	17.6	0.37	44.8

GUIDELINES AND CONTROL SETTINGS					
BTUH/ft		Superheat Set Point @ Bulb (°F)	Evaporator (°F)	Discharge Air (°F)	Discharge Air Velocity (FPM)
Conventional	Parallel				
1646	1440	6 - 8	26	30	270

DEFROST CONTROLS		
Defrosts Per Day	Timed-Off Defrost	
	Fail-Safe (Min)	Termination Temp (F)
6	40	47

NOTES:

- "---" indicates that the feature is not an option on this case model and/or the data is not available at this time.
- Listed BTUH/ft data represent unlighted shelves. For LED lighting, add 9 BTUH/ft per row of lighted shelving.
- BTUH load increases by 132 BTUH/ft when aftermarket merchandising accessories are utilized.
- Listed evaporator temperature represents unlighted shelves. For lighted shelves and/or aftermarket merchandising accessories, reduce the listed evaporator temperature by 2°F.
- Conventional Discharge Air Control – Recommended Settings: Cut-In Temp = Discharge Air + 2°F; Cut-Out Temp = Discharge Air - 2°F.
- Listed discharge air velocity represents the average velocity immediately after defrost.
- Temperature and defrost settings listed above are recommended start-up settings. Final operational settings may need to be adjusted for the store conditions in which the case operates.
- The recommended evaporator temperatures may need to be adjusted based on system setup, store conditions, etc. The minimum recommended evaporator temperature is 4°F below the listed evaporator temperature.



O5MH-NRG

ALL MEASUREMENTS ARE TAKEN PER ASHRAE-72-2005 SPECIFICATIONS. HILLPHOENIX REFRIGERATED DISPLAY CASES FOR SALE IN THE UNITED STATES MEET OR EXCEED DEPARTMENT OF ENERGY 2017 REQUIREMENTS.

Rev Date:	Rev #	Revision Description:
10-16-18	4	PLEXIGLASS DEFLECTOR
9-28-18	3	DATA UPDATE

O5MH-NRG

High Multi-Deck Merchandiser with Synerg-E™
4', 6', 8' & 12' (Deli / Meat)

SECOND NATURE DATA								
Case Model	No. of Coils	Application	Front Sill Type	BTUH/ft (DR)		GPM/ft (DR)	Supply Fluid Temp (F)	Discharge Air Temp (F)
				Conventional	Parallel			
O5MH-NRG	1	Meat	6" Thermopane	1646	1440	0.42	20	30
O5MH-NRG	1	Meat	6" Thermopane	1646	1440	0.99	25	30

SECOND NATURE DATA								
Case Model	No. of Coils	Application	Front Sill Type	No. of Defrost	Timed Off Defrost		Warm Fluid Defrost	
					Fail Safe (Min)	Termination Temp (F)	Fail Safe (Min)	Termination Temp (F)
O5MH-NRG	1	Meat	6" Thermopane	6	60	47	26	49
O5MH-NRG	1	Meat	6" Thermopane	6	45	42	26	49



COMPONENT

ALL MEASUREMENTS ARE TAKEN PER ASHRAE-72-2005 SPECIFICATIONS. HILLPHOENIX REFRIGERATED DISPLAY CASES FOR SALE IN THE UNITED STATES MEET OR EXCEED DEPARTMENT OF ENERGY 2017 REQUIREMENTS.

O5MH-NRG

Rev Date:	Rev #	Revision Description:
10-16-18	4	PLEXIGLASS DEFLECTOR
9-28-18	3	DATA UPDATE

Hillphoenix
A DOVER COMPANY

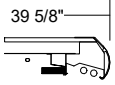
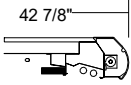
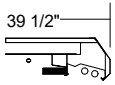
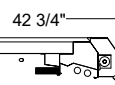
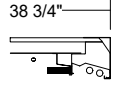
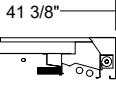
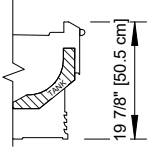
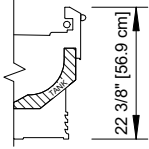
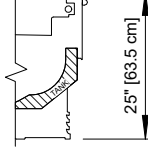
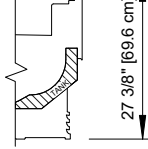
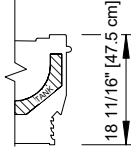
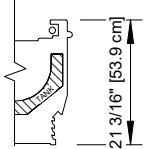
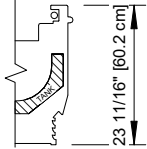
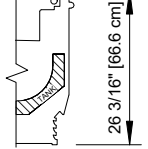
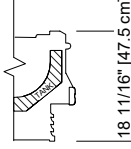
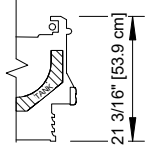
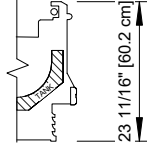
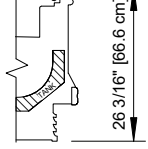
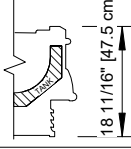
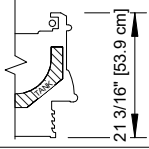
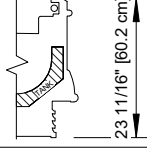
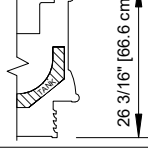
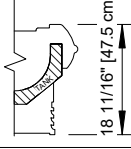
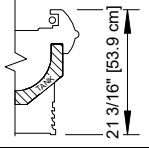
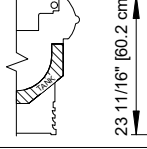
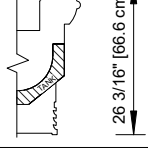
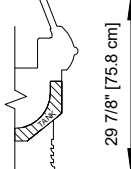
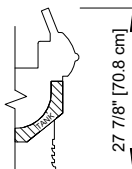
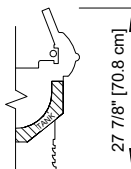
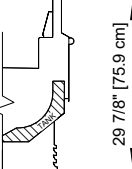
CORNICHE OPTIONS		CURVED CORNICE	CURVED CORNICE WITH NIGHT COVER	FACETED CORNICE	FACETED CORNICE WITH NIGHT COVER	FLAT CORNICE	FLAT CORNICE WITH STANDARD NIGHT COVER
		39 5/8" 	42 7/8" 	39 1/2" 	42 3/4" 	38 3/4" 	41 3/8" 
FRONT OPTIONS	FLAT FRONT 2	STANDARD FRONT  19 7/8" [50.5 cm]	2 1/2" EXTENDED FRONT W/ & W/O NOSE LIGHT  22 3/8" [56.9 cm]	5" EXTENDED FRONT W/ & W/O NOSE LIGHT  25" [63.5 cm]	7 1/2" EXTENDED FRONT  27 3/8" [69.6 cm]		
	FLAT FRONT	STANDARD FRONT  18 11/16" [47.5 cm]	2 1/2" EXTENDED FRONT W/ & W/O NOSE LIGHT  21 3/16" [53.9 cm]	5" EXTENDED FRONT W/ & W/O NOSE LIGHT  23 11/16" [60.2 cm]	7 1/2" EXTENDED FRONT  26 3/16" [66.6 cm]		
	CLASSIC 2 METAL	STANDARD FRONT  18 11/16" [47.5 cm]	2 1/2" EXTENDED FRONT W/ & W/O NOSE LIGHT  21 3/16" [53.9 cm]	5" EXTENDED FRONT W/ & W/O NOSE LIGHT  23 11/16" [60.2 cm]	7 1/2" EXTENDED FRONT  26 3/16" [66.6 cm]		
	CLASSIC 2 POLYMER	STANDARD FRONT  18 11/16" [47.5 cm]	2 1/2" EXTENDED FRONT W/ & W/O NOSE LIGHT  21 3/16" [53.9 cm]	5" EXTENDED FRONT W/ & W/O NOSE LIGHT  23 11/16" [60.2 cm]	7 1/2" EXTENDED FRONT  26 3/16" [66.6 cm]		
	ORIGIN 2	STANDARD FRONT  18 11/16" [47.5 cm]	2 1/2" EXTENDED FRONT W/ & W/O NOSE LIGHT  21 3/16" [53.9 cm]	5" EXTENDED FRONT W/ & W/O NOSE LIGHT  23 11/16" [60.2 cm]	7 1/2" EXTENDED FRONT  26 3/16" [66.6 cm]		
	THERMOPANE	6" THERMOPANE FRONT  29 7/8" [75.8 cm]	4" THERMOPANE FRONT  27 7/8" [70.8 cm]	4" THERMOPANE FRONT W/T NOSE LIGHT  27 7/8" [70.8 cm]	6" THERMOPANE FRONT  29 7/8" [75.8 cm]		

NOTES:

- Front sill and overall case height varies with base frame height.



COMPONENT

ALL MEASUREMENTS ARE TAKEN PER ASHRAE-72-2005 SPECIFICATIONS. HILLPHOENIX REFRIGERATED DISPLAY CASES FOR SALE IN THE UNITED STATES MEET OR EXCEED DEPARTMENT OF ENERGY 2017 REQUIREMENTS.

O5MH-NRG

Rev Date:	Rev #	Revision Description:
10-16-18	4	PLEXIGLASS DEFLECTOR
9-28-18	3	DATA UPDATE

Hillphoenix

A DOVER COMPANY

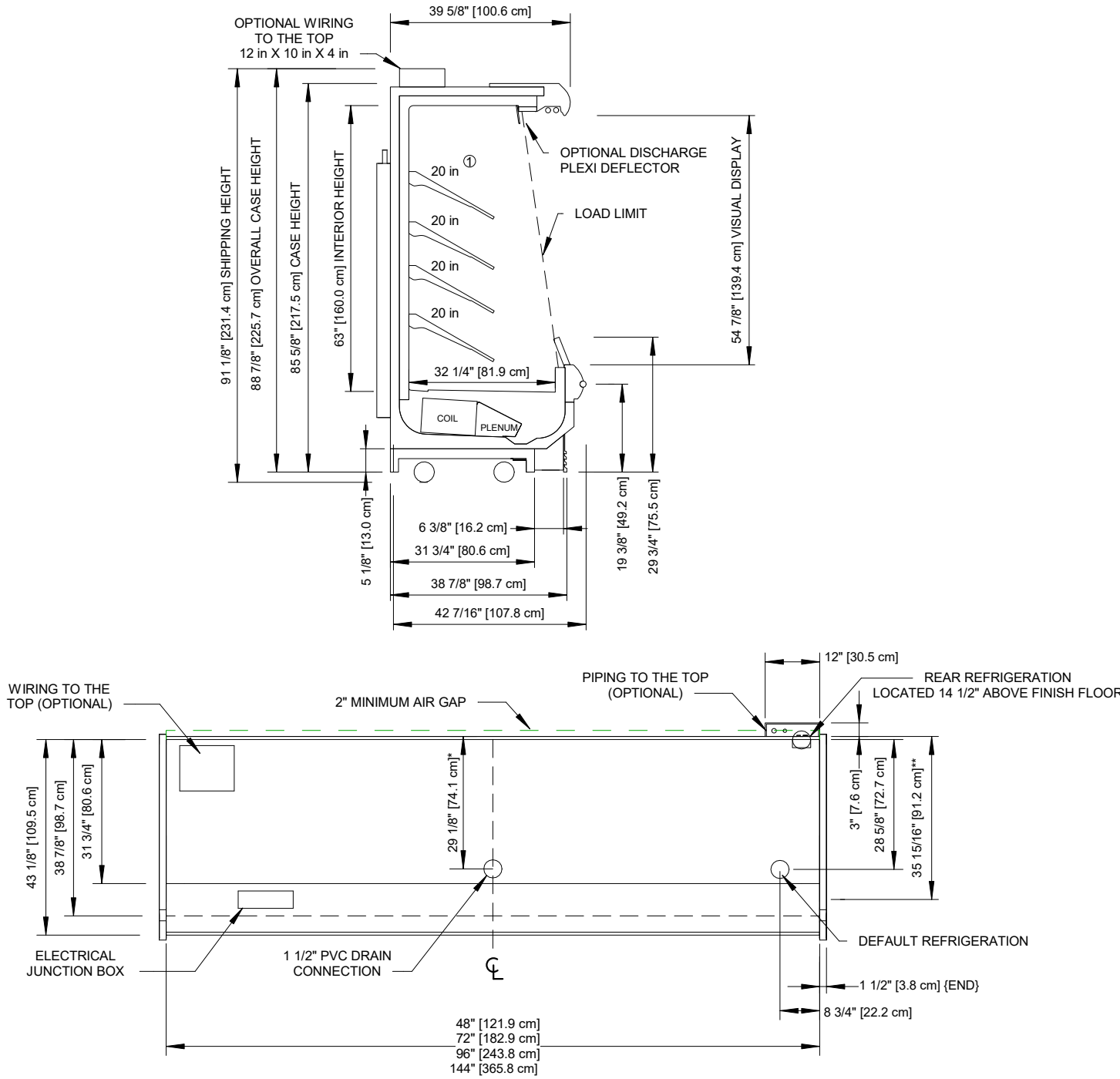

NOTES:

- * :STUB-UP AREA
- ** :RECOMMENDED STUP-UP CENTERLINE FOR ELECTRICAL AND DRAINS
- ① :AVAILABLE SHELF SIZES: 10", 12", 14", 16", 18", 20", 22" & 24"

- Ends add approximately 1" to case height, 1/2" to the back & 1" to the front.
- Back panels add approximately 1" to the rear of the case.



O5MH-NRG

ALL MEASUREMENTS ARE TAKEN PER ASHRAE-72-2005 SPECIFICATIONS. HILLPHOENIX REFRIGERATED DISPLAY CASES FOR SALE IN THE UNITED STATES MEET OR EXCEED DEPARTMENT OF ENERGY 2017 REQUIREMENTS.

Rev Date:	Rev #	Revision Description:
10-16-18	4	PLEXIGLASS DEFLECTOR
9-28-18	3	DATA UPDATE

