

# O5MH-NRG

High Multi-Deck Merchandiser with Synerg-E™  
4', 6', 8' & 12' (Deli / Meat)

## GENERAL NOTES

- "---" indicates that the feature is not an option on this case model and/or the data is not available at this time.
- LED lights only.
- Maximum of 5 rows of Standard Output LED lighted shelves.

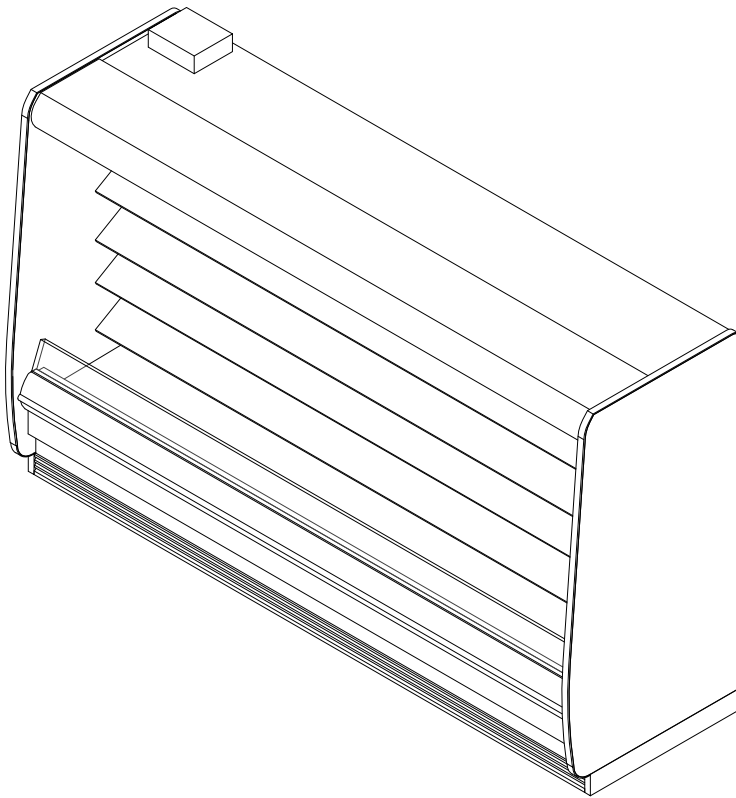

SHIPPING WEIGHT	
Case	Weight
O5MH-NRG	---



ALL MEASUREMENTS ARE TAKEN PER ASHRAE-72-2005 SPECIFICATIONS. HILLPHOENIX REFRIGERATED DISPLAY CASES FOR SALE IN THE UNITED STATES MEET OR EXCEED DEPARTMENT OF ENERGY 2017 REQUIREMENTS.

## O5MH-NRG

Rev. Date	Rev. #	Rev. Title
10-16-18	4	DEFLECTOR
9-28-18	3	DATA UPDATE

**Hillphoenix**  
A DOVER COMPANY

# O5MH-NRG

High Multi-Deck Merchandiser with Synerg-E™  
4', 6', 8' & 12' (Deli / Meat)

ELECTRICAL DATA			
Case Length	Fans Per Case	High Efficiency Fans	
		120 Volt	
		Amps	Watts
4'	2	0.46	36.0
6'	4	0.94	70.0
8'	4	0.94	70.0
12'	6	1.40	106.0

LIGHTING DATA					
Case Length	Lights per row	Clearvoyant v4 LED Lighting (Per Light Row)			
		Standard Power (Cornice or Shelf)		High Power (Cornice Only)	
		120 Volts		120 Volts	
		Amps	Watts	Amps	Watts
4'	1	0.05	5.9	0.12	14.9
6'	2	0.08	9.4	0.20	23.8
8'	2	0.10	11.8	0.25	29.9
12'	3	0.15	17.6	0.37	44.8

GUIDELINES AND CONTROL SETTINGS					
BTUH/ft		Superheat Set Point @ Bulb (°F)	Evaporator (°F)	Discharge Air (°F)	Discharge Air Velocity (FPM)
Conventional	Parallel				
1646	1440	6 - 8	26	30	270

DEFROST CONTROLS		
Defrosts Per Day	Timed-Off Defrost	
	Fail-Safe (Min)	Termination Temp (F)
6	40	47

## NOTES:

- "----" indicates that the feature is not an option on this case model and/or the data is not available at this time.
- Listed BTUH/ft data represent unlighted shelves. For LED lighting, add 9 BTUH/ft per row of lighted shelving.
- BTUH load increases by 132 BTUH/ft when aftermarket merchandising accessories are utilized.
- Listed evaporator temperature represents unlighted shelves. For lighted shelves and/or aftermarket merchandising accessories, reduce the listed evaporator temperature by 2°F.
- Conventional Discharge Air Control – Recommended Settings: Cut-In Temp = Discharge Air + 2°F; Cut-Out Temp = Discharge Air - 2°F.
- Listed discharge air velocity represents the average velocity immediately after defrost.
- Temperature and defrost settings listed above are recommended start-up settings. Final operational settings may need to be adjusted for the store conditions in which the case operates.
- The recommended evaporator temperatures may need to be adjusted based on system setup, store conditions, etc. The minimum recommended evaporator temperature is 4°F below the listed evaporator temperature.



ALL MEASUREMENTS ARE TAKEN PER ASHRAE-72-2005 SPECIFICATIONS. HILLPHOENIX REFRIGERATED DISPLAY CASES FOR SALE IN THE UNITED STATES MEET OR EXCEED DEPARTMENT OF ENERGY 2017 REQUIREMENTS.

## O5MH-NRG

Rev. Date	Rev. #	Rev. Title
10-16-18	4	DEFLECTOR
9-28-18	3	DATA UPDATE

**Hillphoenix**  
A DOVER COMPANY

# O5MH-NRG

High Multi-Deck Merchandiser with Synerg-E™  
4', 6', 8' & 12' (Deli / Meat)

## SECOND NATURE DATA

Case Model	No. of Coils	Application	Front Sill Type	BTUH/ft (DR)		GPM/ft (DR)	Supply Fluid Temp (F)	Discharge Air Temp (F)
				Conventional	Parallel			
O5MH-NRG	1	Meat	6" Thermopane	1646	1440	0.42	20	30
O5MH-NRG	1	Meat	6" Thermopane	1646	1440	0.99	25	30

## SECOND NATURE DATA

Case Model	No. of Coils	Application	Front Sill Type	No. of Defrost	Timed Off Defrost		Warm Fluid Defrost	
					Fail Safe (Min)	Termination Temp (F)	Fail Safe (Min)	Termination Temp (F)
O5MH-NRG	1	Meat	6" Thermopane	6	60	47	26	49
O5MH-NRG	1	Meat	6" Thermopane	6	45	42	26	49



2017 DOE COMPLIANT COMPONENT  
ALL MEASUREMENTS ARE TAKEN PER ASHRAE-72-2005 SPECIFICATIONS. HILLPHOENIX REFRIGERATED DISPLAY CASES FOR SALE IN THE UNITED STATES MEET OR EXCEED DEPARTMENT OF ENERGY 2017 REQUIREMENTS.





## O5MH-NRG

Rev. Date	Rev. #	Rev. Title
10-16-18	4	DEFLECTOR
9-28-18	3	DATA UPDATE

**Hillphoenix**  
A DOVER COMPANY

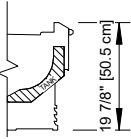
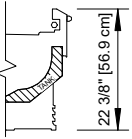
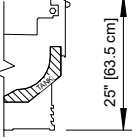
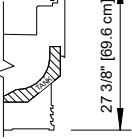
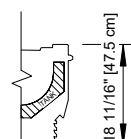
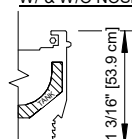
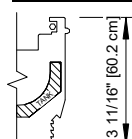
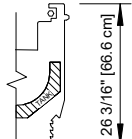
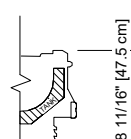
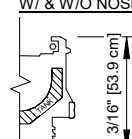
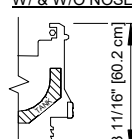
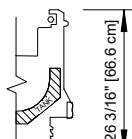
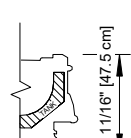
# O5MH-NRG

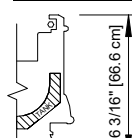
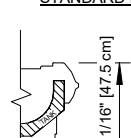
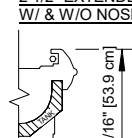
High Multi-Deck Merchandiser with Synerg-E™  
4', 6', 8' & 12' (Deli / Meat)

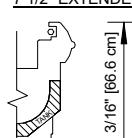
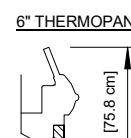
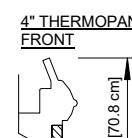
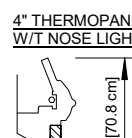
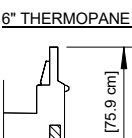
FRONT OPTIONS	CORNICE OPTIONS					
	CURVED CORNICE 39 5/8"	CURVED CORNICE WITH NIGHT COVER 42 7/8"	FACETED CORNICE 39 1/2"	FACETED CORNICE WITH NIGHT COVER 42 3/4"	FLAT CORNICE 38 3/4"	FLAT CORNICE WITH STANDARD NIGHT COVER 41 3/8"
FLAT FRONT 2	STANDARD FRONT  19 7/8" [50.5 cm]	2 1/2" EXTENDED FRONT W/ & W/O NOSE LIGHT  22 3/8" [56.9 cm]	5" EXTENDED FRONT W/ & W/O NOSE LIGHT  25" [63.5 cm]	7 1/2" EXTENDED FRONT  27 3/8" [69.6 cm]		
FLAT FRONT	STANDARD FRONT  18 11/16" [47.5 cm]	2 1/2" EXTENDED FRONT W/ & W/O NOSE LIGHT  21 3/16" [53.9 cm]	5" EXTENDED FRONT W/ & W/O NOSE LIGHT  23 11/16" [60.2 cm]	7 1/2" EXTENDED FRONT  26 3/16" [66.6 cm]		
CLASSIC 2 METAL	STANDARD FRONT  18 11/16" [47.5 cm]	2 1/2" EXTENDED FRONT W/ & W/O NOSE LIGHT  21 3/16" [53.9 cm]	5" EXTENDED FRONT W/ & W/O NOSE LIGHT  23 11/16" [60.2 cm]	7 1/2" EXTENDED FRONT  26 3/16" [66.6 cm]		
CLASSIC 2 POLYMER	STANDARD FRONT  18 11/16" [47.5 cm]	2 1/2" EXTENDED FRONT W/ & W/O NOSE LIGHT  21 3/16" [53.9 cm]	5" EXTENDED FRONT W/ & W/O NOSE LIGHT  23 11/16" [60.2 cm]	7 1/2" EXTENDED FRONT  26 3/16" [66.6 cm]		
ORIGIN 2	STANDARD FRONT  18 11/16" [47.5 cm]	2 1/2" EXTENDED FRONT W/ & W/O NOSE LIGHT  21 3/16" [53.9 cm]	5" EXTENDED FRONT W/ & W/O NOSE LIGHT  23 11/16" [60.2 cm]	7 1/2" EXTENDED FRONT  26 3/16" [66.6 cm]		
THERMOPANE	6" THERMOPANE FRONT  29 7/8" [75.8 cm]	4" THERMOPANE FRONT  27 7/8" [70.8 cm]	4" THERMOPANE FRONT W/T NOSE LIGHT  27 7/8" [70.8 cm]	6" THERMOPANE FRONT  29 7/8" [75.9 cm]		

**NOTES:**

- Front sill and overall case height varies with base frame height.



ALL MEASUREMENTS ARE TAKEN PER ASHRAE-72-2005 SPECIFICATIONS. HILLPHOENIX REFRIGERATED DISPLAY CASES FOR SALE IN THE UNITED STATES MEET OR EXCEED DEPARTMENT OF ENERGY 2017 REQUIREMENTS.

**O5MH-NRG**

Rev. Date	Rev. #	Rev. Title
10-16-18	4	DEFLECTOR
9-28-18	3	DATA UPDATE



# O5MH-NRG

High Multi-Deck Merchandiser with Synerg-E™  
4', 6', 8' & 12' (Deli / Meat)

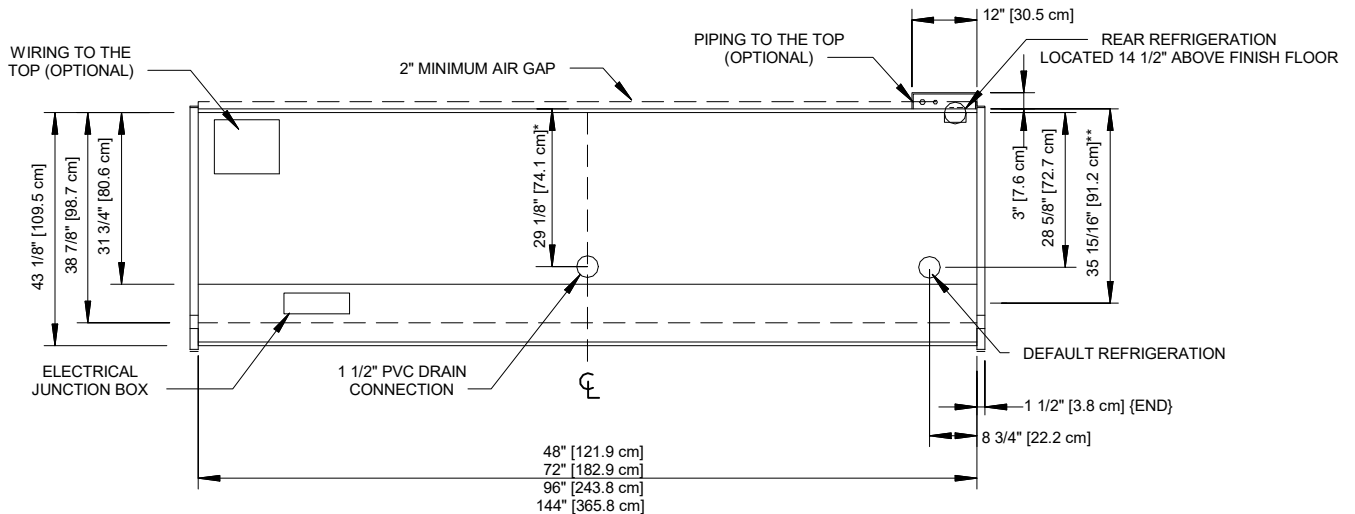
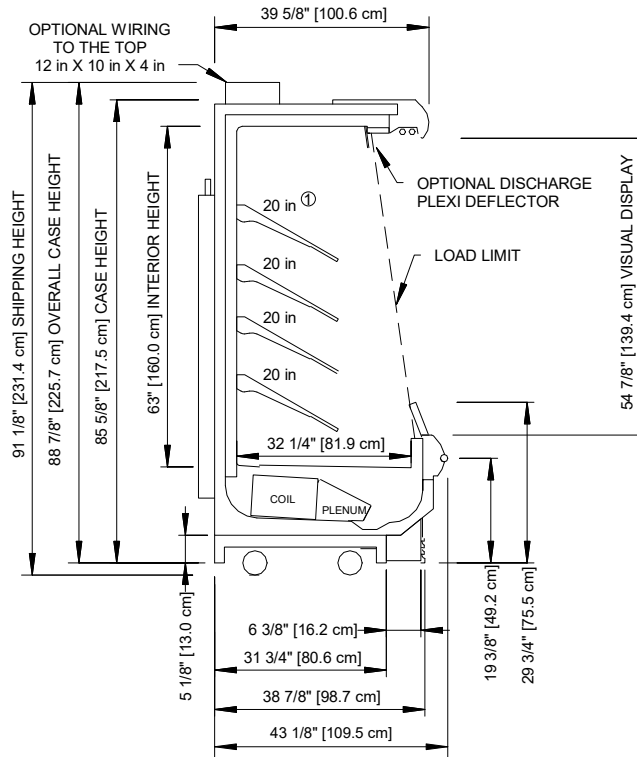

**NOTES:**

- \* :STUB-UP AREA
- \*\* :RECOMMENDED STUB-UP CENTERLINE FOR ELECTRICAL AND DRAINS
- ⊙ :AVAILABLE SHELF SIZES: 10", 12", 14", 16", 18", 20", 22" & 24"

- Ends add approximately 1" to case height, 1/2" to the back & 1" to the front.
- Back panels add approximately 1" to the rear of the case.



ALL MEASUREMENTS ARE TAKEN PER ASHRAE-72-2005 SPECIFICATIONS. HILLPHOENIX REFRIGERATED DISPLAY CASES FOR SALE IN THE UNITED STATES MEET OR EXCEED DEPARTMENT OF ENERGY 2017 REQUIREMENTS.

**O5MH-NRG**

Rev. Date	Rev. #	Rev. Title
10-16-18	4	DEFLECTOR
9-28-18	3	DATA UPDATE

