

O6UM-NRG

Multi-Deck Merchandiser with Synerg-E™
4', 6', 8', & 12' Dairy/Deli/Meat/Produce

GENERAL NOTES:

- "---" indicates that the feature is not an option with this case model and/or the data is not available at this time.
- LED lights only.
- Nose lights are not available.

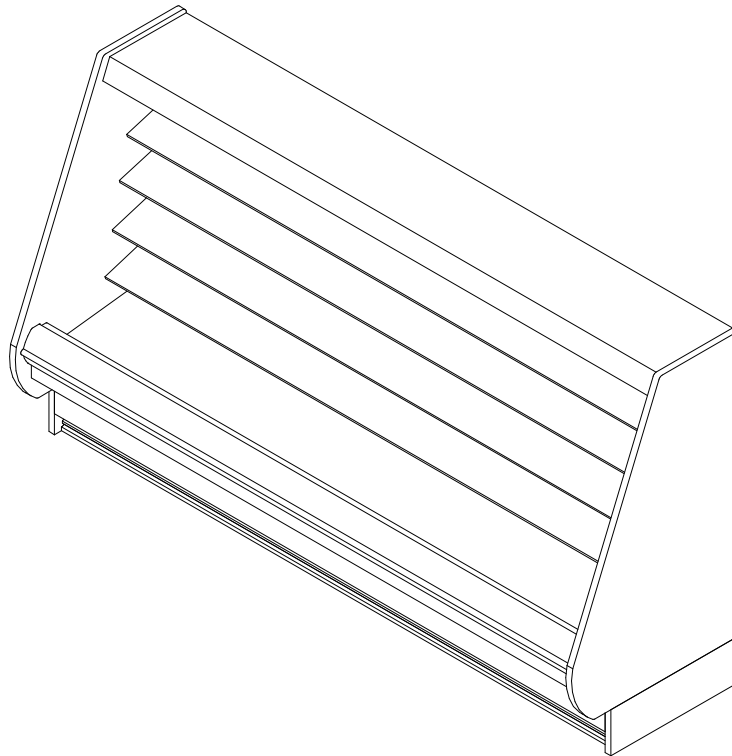

SHIPPING WEIGHT	
Case	Weight
O6UM-NRG	---



ALL MEASUREMENTS ARE TAKEN PER ASHRAE-72-2005 SPECIFICATIONS. HILLPHOENIX REFRIGERATED DISPLAY CASES FOR SALE IN THE UNITED STATES MEET OR EXCEED DEPARTMENT OF ENERGY 2017 REQUIREMENTS.

O6UM-NRG

Rev. Date	Rev. #	Rev. Title
5-20-19	4	ENDVIEW UPDATE
9-10-18	3	DATA UPDATE



O6UM-NRG

Multi-Deck Merchandiser with Synerg-E™
4', 6', 8', & 12' Dairy/Deli/Meat/Produce

ELECTRICAL DATA			
Case Length	Fans Per Case	High Efficiency Fans	
		120 Volts	
		Amps	Watts
4'	1	0.20	14.0
6'	2	0.40	28.0
8'	2	0.40	28.0
12'	3	0.60	42.0

LIGHTING DATA						
Case Length	Lights per row	Lights Length	Clearvoyant LED Lighting (Per Light Row)			
			Standard Power (Cornice or Shelf)		High Power (Cornice)	
			120 Volts		120 Volts	
			Amps	Watts	Amps	Watts
4'	1	4'	0.05	5.9	0.12	14.9
6'	2	3'	0.08	9.4	0.20	23.8
8'	2	4'	0.10	11.8	0.25	29.9
12'	3	4'	0.15	17.6	0.37	44.8

GUIDELINES AND CONTROL SETTINGS							
Application	Front Sill Height	BTUH/ft		Superheat Set Point @ Bulb (°F)	Evaporator (°F)	Discharge Air (°F)	Discharge Air Velocity (FPM)
		Conventional	Parallel				
Dairy/Deli/Produce	All	1223	1070	6 - 8	28	31	180
Meat	Extended	1216	1064	6 - 8	26	30	180

DEFROST CONTROLS		
Defrosts Per Day	Timed-Off Defrost	
	Fail-Safe (Min)	Termination Temp (°F)
6	30	47

NOTES:

- "---" indicates that the feature is not an option with this case model and/or the data is not available at this time.
- Listed anti-condensate heater data represent an unlighted rear sill.
- Listed BTUH/ft data represent unlighted shelves. For LED lighting, add 9 BTUH/ft per row of lighted shelving.
- Listed discharge air velocity represents the average velocity immediately after defrost.
- Temperature and defrost settings listed above are recommended start-up settings. Final operational settings may need to be adjusted for the store conditions in which the case operates.
- The recommended evaporator temperatures may need to be adjusted based on system setup, store conditions, etc. The minimum recommended evaporator temperature is 4°F below the listed evaporator temperature.
- Timed-off defrost is recommended for medium temperature applications.



ALL MEASUREMENTS ARE TAKEN PER ASHRAE-72-2005 SPECIFICATIONS. HILLPHOENIX REFRIGERATED DISPLAY CASES FOR SALE IN THE UNITED STATES MEET OR EXCEED DEPARTMENT OF ENERGY 2017 REQUIREMENTS.

O6UM-NRG

Rev. Date	Rev. #	Rev. Title
5-20-19	4	ENDVIEW UPDATE
9-10-18	3	DATA UPDATE

Hillphoenix
A DOVER COMPANY

O6UM-NRG

Multi-Deck Merchandiser with Synerg-E™
4', 6', 8', & 12' Dairy/Deli/Meat/Produce

SECOND NATURE DATA

Case Model	No. of Coils	Application	Front Sill Type	BTUH/FT (DR)		GPM/ft (DR)	Supply Fluid Temp (°F)	Discharge Air Temp (°F)
				Conventional	Parallel			
O6UM-NRG	1	Deli	Standard	1223	1070	0.32	20	29
O6UM-NRG	1	Meat	3" Extended	1216	1064	0.38	20	29
O6UM-NRG	1	Deli	Standard	1223	1070	0.82	25	29
O6UM-NRG	1	Meat	3" Extended	1216	1064	1.14	25	29

SECOND NATURE DATA

Case Model	No. of Coils	Application	Front Sill Type	No. of Defrost	Timed-Off Defrost		Warm Fluid Defrost	
					Fail Safe (Min)	Termination Temp (°F)	Fail Safe (Min)	Termination Temp (°F)
O6UM-NRG	1	Deli	Standard	6	60	47	26	49
O6UM-NRG	1	Meat	3" Extended	6	60	47	26	49
O6UM-NRG	1	Deli	Standard	6	45	42	26	49
O6UM-NRG	1	Meat	3" Extended	6	45	42	26	49



ALL MEASUREMENTS ARE TAKEN PER ASHRAE-72-2005 SPECIFICATIONS. HILLPHOENIX REFRIGERATED DISPLAY CASES FOR SALE IN THE UNITED STATES MEET OR EXCEED DEPARTMENT OF ENERGY 2017 REQUIREMENTS.

O6UM-NRG

Rev. Date	Rev. #	Rev. Title
5-20-19	4	ENDVIEW UPDATE
9-10-18	3	DATA UPDATE



A DOVER COMPANY

O6UM-NRG

Multi-Deck Merchandiser with Synerg-E™
4', 6', 8', & 12' Dairy/Deli/Meat/Produce

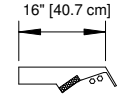
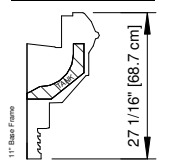
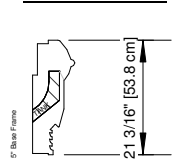
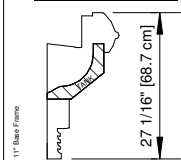
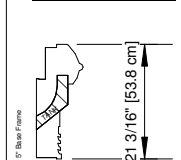
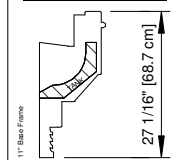
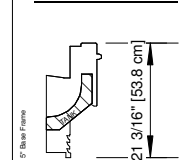
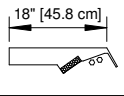
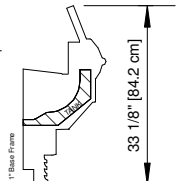
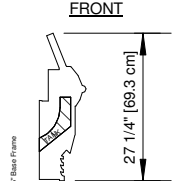
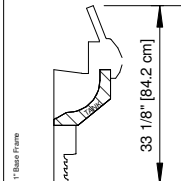
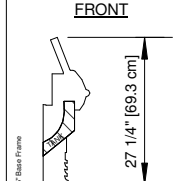
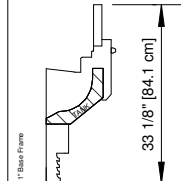
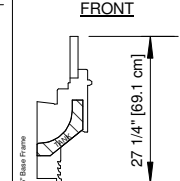
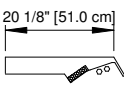
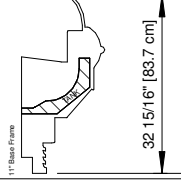
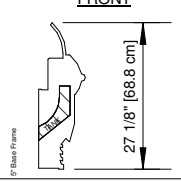
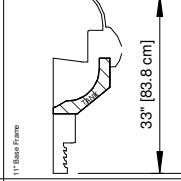
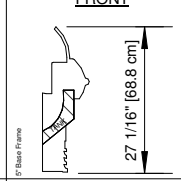
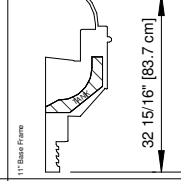
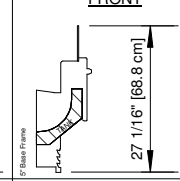
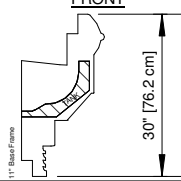
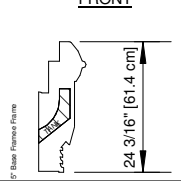
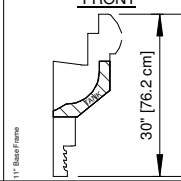
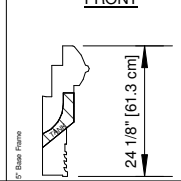
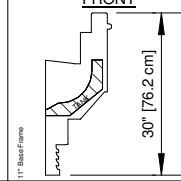
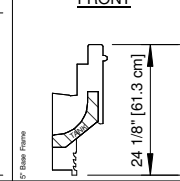
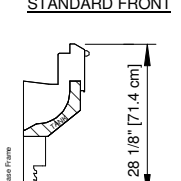
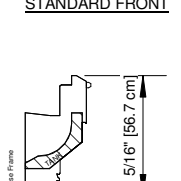
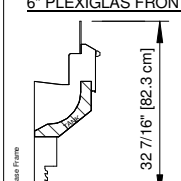
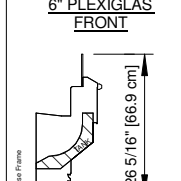
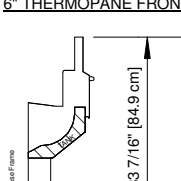
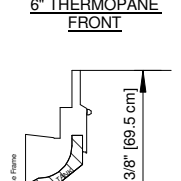
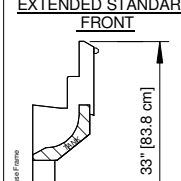
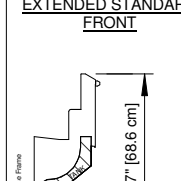
REAR SILL OPTIONS	FRONT OPTIONS					
	ORIGIN 2 FRONT				FLAT FRONT FLAT TOP	
	STANDARD FRONT	STANDARD FRONT	STANDARD FRONT	STANDARD FRONT	STANDARD FRONT	STANDARD FRONT
16" REAR SILL (FRONT DISCHARGE)  16" [40.7 cm]	 11" Base Frame 27 1/16" [68.7 cm]	 5" Base Frame 21 3/16" [53.8 cm]	 11" Base Frame 27 1/16" [68.7 cm]	 5" Base Frame 21 3/16" [53.8 cm]	 11" Base Frame 27 1/16" [68.7 cm]	 5" Base Frame 21 3/16" [53.8 cm]
18" REAR SILL (FRONT DISCHARGE)  18" [45.8 cm]	 11" Base Frame 33 1/8" [84.2 cm]	 5" Base Frame 27 1/4" [69.3 cm]	 11" Base Frame 33 1/8" [84.2 cm]	 5" Base Frame 27 1/4" [69.3 cm]	 11" Base Frame 33 1/8" [84.1 cm]	 5" Base Frame 27 1/4" [69.1 cm]
20" REAR SILL (FRONT DISCHARGE)  20 1/8" [51.0 cm]	 11" Base Frame 32 15/16" [83.7 cm]	 5" Base Frame 27 1/8" [68.8 cm]	 11" Base Frame 33" [83.8 cm]	 5" Base Frame 27 1/16" [68.8 cm]	 11" Base Frame 32 15/16" [83.7 cm]	 5" Base Frame 27 1/16" [68.8 cm]
	EXTENDED STANDARD FRONT  11" Base Frame 30" [76.2 cm]	EXTENDED STANDARD FRONT  5" Base Frame 24 3/16" [61.4 cm]	EXTENDED STANDARD FRONT  11" Base Frame 30" [76.2 cm]	EXTENDED STANDARD FRONT  5" Base Frame 24 1/8" [61.3 cm]	EXTENDED STANDARD FRONT  11" Base Frame 30" [76.2 cm]	EXTENDED STANDARD FRONT  5" Base Frame 24 1/8" [61.3 cm]
	FLAT FRONT ANGLED TOP					
	STANDARD FRONT  11" Base Frame 28 1/8" [71.4 cm]	STANDARD FRONT  5" Base Frame 22 5/16" [56.7 cm]	6" PLEXIGLAS FRONT  11" Base Frame 32 7/16" [82.3 cm]	6" PLEXIGLAS FRONT  5" Base Frame 26 5/16" [66.9 cm]		
	6" THERMOPANE FRONT  11" Base Frame 33 7/16" [84.9 cm]	6" THERMOPANE FRONT  5" Base Frame 27 3/8" [69.5 cm]	EXTENDED STANDARD FRONT  11" Base Frame 33" [83.8 cm]	EXTENDED STANDARD FRONT  5" Base Frame 27" [68.6 cm]		

NOTES:

- Front and rear sill height vary with baseframe.
- Extended front sills are required for meat applications to maintain proper product temperature. An extended front has a minimum height of 24" on a 5" baseframe, or 30" on an 11" baseframe.



COMPONENT

ALL MEASUREMENTS ARE TAKEN PER ASHRAE-72-2005 SPECIFICATIONS. HILLPHOENIX REFRIGERATED DISPLAY CASES FOR SALE IN THE UNITED STATES MEET OR EXCEED DEPARTMENT OF ENERGY 2017 REQUIREMENTS.

O6UM-NRG

Rev. Date	Rev. #	Rev. Title
5-20-19	4	ENDVIEW UPDATE
9-10-18	3	DATA UPDATE



A DOVER COMPANY

O6UM-NRG

Multi-Deck Merchandiser with Synerg-E™
4', 6', 8', & 12' Dairy/Deli/Meat/Produce

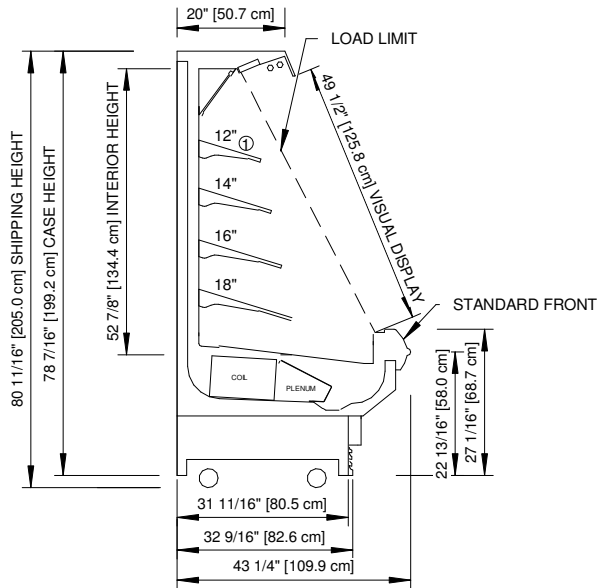

11" BASEFRAME

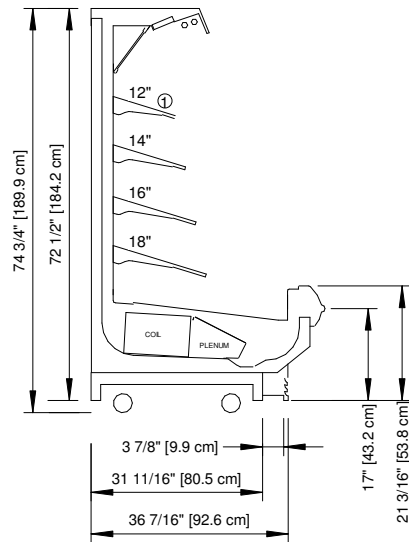

5" BASEFRAME

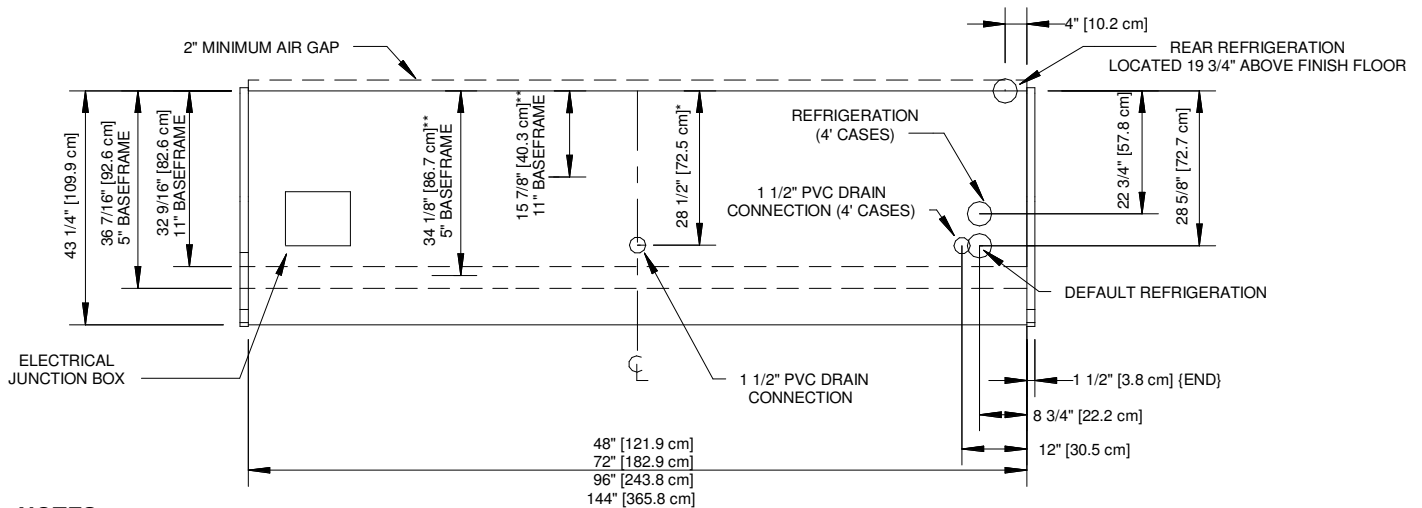

NOTES:

- * :STUB-UP AREA
- ** :RECOMMENDED STUB-UP CENTERLINE FOR ELECTRICAL AND HUB DRAINS AVAILABLE UPON REQUEST
- Ⓛ :AVAILABLE SHELF SIZES: 10", 12", 14", 16" & 18"

- Ends add approximately 1 inch to case height, 1" to the front and 1/2" to the back.
- Product on top shelf should be 3 inches below discharge.



O6UM-NRG

ALL MEASUREMENTS ARE TAKEN PER ASHRAE-72-2005 SPECIFICATIONS. HILLPHOENIX REFRIGERATED DISPLAY CASES FOR SALE IN THE UNITED STATES MEET OR EXCEED DEPARTMENT OF ENERGY 2017 REQUIREMENTS.

Rev. Date	Rev. #	Rev. Title
5-20-19	4	ENDVIEW UPDATE
9-10-18	3	DATA UPDATE

