

ON5DMHX-NRG

High Narrow Multi-Deck Merchandiser with Synerg-E™
4', 6', 8' & 12' (Beverage / Dairy / Produce)

GENERAL NOTES:

- "---" indicates that the feature is not an option for this case model and/or the data is not yet available.
- LED lights only.
- Maximum of 5 rows of standard output LED lighted shelves.

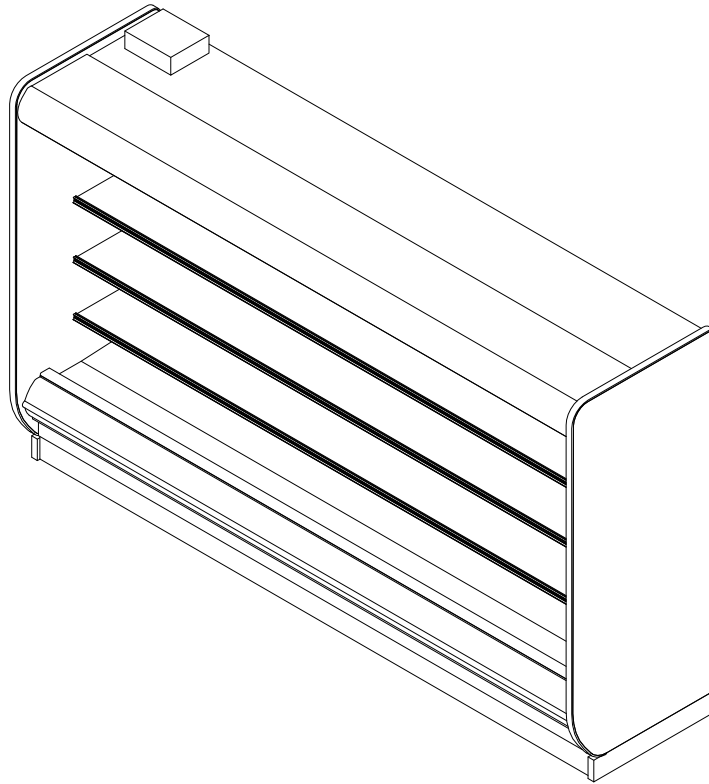

SHIPPING WEIGHT	
Case	Weight
ON5DMHX-NRG	---



ALL MEASUREMENTS ARE TAKEN PER ASHRAE-72-2005 SPECIFICATIONS. HILLPHOENIX REFRIGERATED DISPLAY CASES FOR SALE IN THE UNITED STATES MEET OR EXCEED DEPARTMENT OF ENERGY 2017 REQUIREMENTS.

ON5DMHX-NRG

Rev. Date	Rev. #	Rev. Title
3-8-19	4	ENDVIEW UPDATE
9-17-18	3	DATA UPDATE

Hillphoenix
A DOVER COMPANY

ON5DMHX-NRG

High Narrow Multi-Deck Merchandiser with Synerg-E™
4', 6', 8' & 12' (Beverage / Dairy / Produce)

ELECTRICAL DATA			
Case Length	Fans Per Case	High Efficiency Fans	
		120 Volt	
		Amps	Watts
4'	1	0.23	18.0
6'	2	0.47	35.0
8'	2	0.47	35.0
12'	3	0.70	53.0

LIGHTING DATA					
Case Length	Lights per row	Clearvoyant v4 LED Lighting (Per Light Row)			
		Standard Power (Cornice or Shelf)		High Power (Cornice Only)	
		120 Volts		120 Volts	
		Amps	Watts	Amps	Watts
4'	1	0.05	5.9	0.12	14.9
6'	2	0.08	9.4	0.20	23.8
8'	2	0.10	11.8	0.25	29.9
12'	3	0.15	17.7	0.37	44.7

GUIDELINES AND CONTROL SETTINGS							
Application	Front Sill height	BTUH/ft		Superheat Set Point @ Bulb (°F)	Evaporator (°F)	Discharge Air (°F)	Discharge Air Velocity (FPM)
		Conventional	Parallel				
Beverage/Bulk Produce	2.5" Extended	1231	1200	6 - 8	34	37	210
Beverage/Bulk Produce	5" Extended	1209	1175	6 - 8	34	37	210
Beverage/Bulk Produce	7.5" Extended	1188	1155	6 - 8	34	37	210
Beverage/Bulk Produce	Std. Dairy	1270	1235	6 - 8	34	37	210
Dairy/Deli/Cut Produce	2.5" Extended	1611	1410	6 - 8	28	31	210
Dairy/Deli/Cut Produce	5" Extended	1583	1385	6 - 8	28	31	210
Dairy/Deli/Cut Produce	7.5" Extended	1560	1365	6 - 8	28	31	210
Dairy/Deli/Cut Produce	Std. Dairy	1651	1445	6 - 8	28	31	210

DEFROST CONTROLS			
Application	Defrosts Per Day	Timed-Off Defrost	
		Fail-Safe (Min)	Termination Temp (F)
Beverage/Bulk Produce	2	30	47
Dairy/Deli/Cut Produce	6	40	47

NOTES:

- "----" indicates that the feature is not an option for case model.
- Listed BTUH/ft data represent unlighted shelves. For LED lighting, add 9 BTUH/ft per row of lighted shelving.
- BTUH load increases by 132 BTUH/ft when aftermarket merchandising accessories are utilized.
- Listed evaporator temperature represents unlighted shelves. For lighted shelves and/or aftermarket merchandising accessories, reduce the listed evaporator temperature by 2°F.
- Conventional Discharge Air Control – Recommended Settings: Cut-In Temp = Discharge Air + 2°F; Cut-Out Temp = Discharge Air - 2°F.
- Listed discharge air velocity represents the average velocity immediately after defrost.
- Temperature and defrost settings listed above are recommended start-up settings. Final operational settings may need to be adjusted for the store conditions in which the case operates.
- The recommended evaporator temperatures may need to be adjusted based on system setup, store conditions, etc. The minimum recommended evaporator temperature is 4°F below the listed evaporator temperature.



ON5DMHX-NRG





ALL MEASUREMENTS ARE TAKEN PER ASHRAE-72-2005 SPECIFICATIONS. HILLPHOENIX REFRIGERATED DISPLAY CASES FOR SALE IN THE UNITED STATES MEET OR EXCEED DEPARTMENT OF ENERGY 2017 REQUIREMENTS.

Rev. Date	Rev. #	Rev. Title
3-8-19	4	ENDVIEW UPDATE
9-17-18	3	DATA UPDATE

Hillphoenix
A DOVER COMPANY

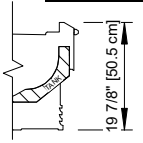
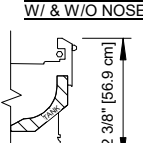
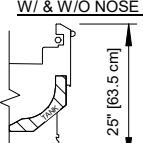
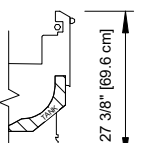
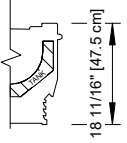
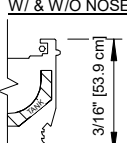
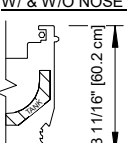
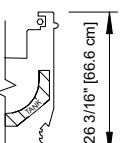
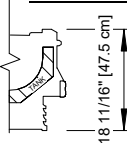
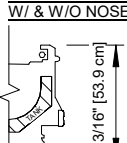
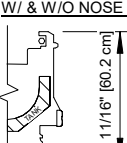
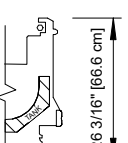
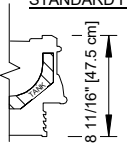
ON5DMHX-NRG

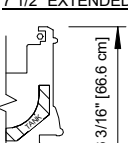
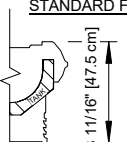
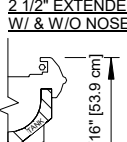
High Narrow Multi-Deck Merchandiser with Synerg-E™
4', 6', 8' & 12' (Beverage / Dairy / Produce)

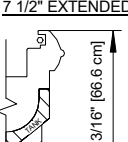
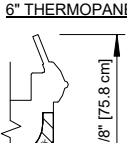
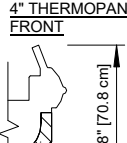
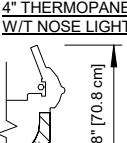
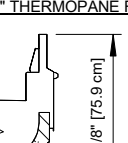
FRONT OPTIONS	CORNICE OPTIONS	CURVED CORNICE	CURVED CORNICE WITH NIGHT COVER	FACETED CORNICE	FACETED CORNICE WITH NIGHT COVER	FLAT CORNICE	FLAT CORNICE WITH STANDARD NIGHT COVER			
		37"	40 1/4"	36 7/8"	40 1/8"	36 1/8"	38 3/4"			
FRONT OPTIONS	FLAT FRONT 2	STANDARD FRONT  19 7/8" [50.5 cm]	2 1/2" EXTENDED FRONT W/ & W/O NOSE LIGHT  22 3/8" [56.9 cm]	5" EXTENDED FRONT W/ & W/O NOSE LIGHT  25" [63.5 cm]	7 1/2" EXTENDED FRONT  27 3/8" [69.6 cm]	FLAT FRONT	STANDARD FRONT  18 11/16" [47.5 cm]	2 1/2" EXTENDED FRONT W/ & W/O NOSE LIGHT  21 3/16" [53.9 cm]	5" EXTENDED FRONT W/ & W/O NOSE LIGHT  23 11/16" [60.2 cm]	7 1/2" EXTENDED FRONT  26 3/16" [66.6 cm]
	CLASSIC 2 METAL	STANDARD FRONT  18 11/16" [47.5 cm]	2 1/2" EXTENDED FRONT W/ & W/O NOSE LIGHT  21 3/16" [53.9 cm]	5" EXTENDED FRONT W/ & W/O NOSE LIGHT  23 11/16" [60.2 cm]	7 1/2" EXTENDED FRONT  26 3/16" [66.6 cm]	CLASSIC 2 POLYMER	STANDARD FRONT  18 11/16" [47.5 cm]	2 1/2" EXTENDED FRONT W/ & W/O NOSE LIGHT  21 3/16" [53.9 cm]	5" EXTENDED FRONT W/ & W/O NOSE LIGHT  23 11/16" [60.2 cm]	7 1/2" EXTENDED FRONT  26 3/16" [66.6 cm]
	ORIGIN 2	STANDARD FRONT  18 11/16" [47.5 cm]	2 1/2" EXTENDED FRONT W/ & W/O NOSE LIGHT  21 3/16" [53.9 cm]	5" EXTENDED FRONT W/ & W/O NOSE LIGHT  23 11/16" [60.2 cm]	7 1/2" EXTENDED FRONT  26 3/16" [66.6 cm]	THERMOPANE	6" THERMOPANE FRONT  29 7/8" [75.8 cm]	4" THERMOPANE FRONT  27 7/8" [70.8 cm]	4" THERMOPANE FRONT W/T NOSE LIGHT  27 7/8" [70.8 cm]	6" THERMOPANE FRONT  29 7/8" [75.9 cm]



COMPONENT

ALL MEASUREMENTS ARE TAKEN PER ASHRAE-72-2005 SPECIFICATIONS. HILLPHOENIX REFRIGERATED DISPLAY CASES FOR SALE IN THE UNITED STATES MEET OR EXCEED DEPARTMENT OF ENERGY 2017 REQUIREMENTS.

ON5DMHX-NRG

Rev. Date	Rev. #	Rev. Title
3-8-19	4	ENDVIEW UPDATE
9-17-18	3	DATA UPDATE

Hillphoenix
A DOVER COMPANY

ON5DMHX-NRG

High Narrow Multi-Deck Merchandiser with Synerg-E™
4', 6', 8' & 12' (Beverage / Dairy / Produce)

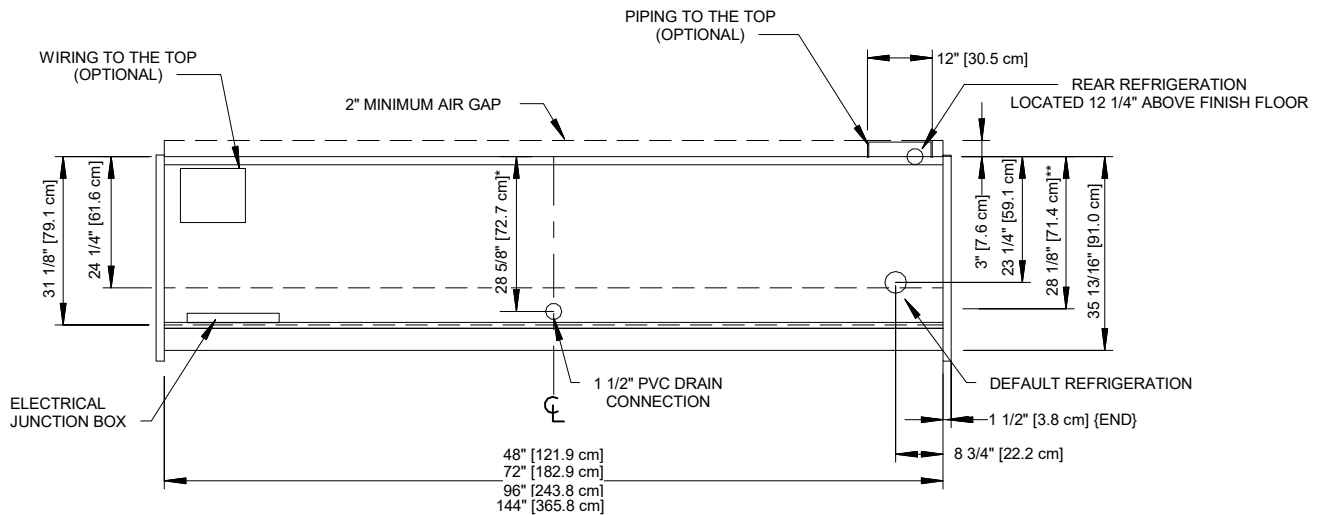
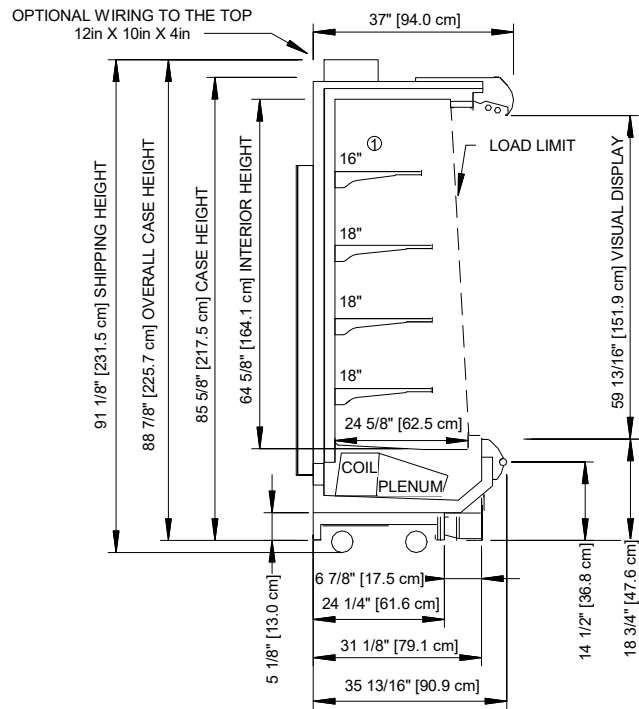

NOTES:

- * : STUB-UP AREA
- ** : RECOMMENDED STUP-UP CENTERLINE FOR ELECTRICAL AND HUB DRAINS
- ① : AVAILABLE SHELF SIZES: 10", 12", 14", 16", 18" & 20"

• Ends add approximately 1" to case height, 1/2" to the back and 1" to the front.



ALL MEASUREMENTS ARE TAKEN PER ASHRAE-72-2005 SPECIFICATIONS. HILLPHOENIX REFRIGERATED DISPLAY CASES FOR SALE IN THE UNITED STATES MEET OR EXCEED DEPARTMENT OF ENERGY 2017 REQUIREMENTS.

ON5DMHX-NRG

Rev. Date	Rev. #	Rev. Title
3-8-19	4	ENDVIEW UPDATE
9-17-18	3	DATA UPDATE

