

ON5MHX-NRG

High Multi-Deck Merchandiser with Synerg-E™
4', 6', 8' & 12' (Deli / Meat)

GENERAL NOTES

- "---" indicates that the feature is not an option for this case model and/or that the data is not yet available.
- LED lights only.
- Maximum of 5 rows of standard output LED lighted shelves.

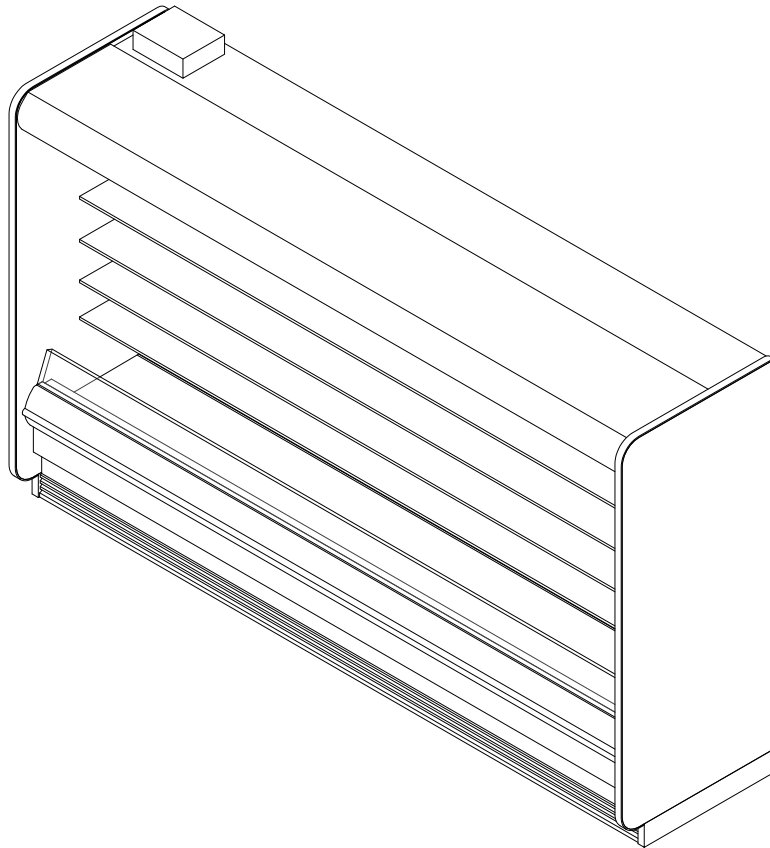

| SHIPPING WEIGHT | |
|-----------------|--------|
| Case | Weight |
| ON5MHX-NRG | --- |



COMPONENT

ALL MEASUREMENTS ARE TAKEN PER ASHRAE-72-2005 SPECIFICATIONS. HILLPHOENIX REFRIGERATED DISPLAY CASES FOR SALE IN THE UNITED STATES MEET OR EXCEED DEPARTMENT OF ENERGY 2017 REQUIREMENTS.

ON5MHX-NRG

| Rev Date: | Rev # | Revision Description: |
|-----------|-------|-----------------------|
| 9-17-18 | 3 | DATA UPDATE |
| 7-9-18 | 2 | NEW STANDARDS |

Hillphoenix
A DOVER COMPANY

ON5MHX-NRG

High Multi-Deck Merchandiser with Synerg-E™
4', 6', 8' & 12' (Deli / Meat)

| ELECTRICAL DATA | | | |
|-----------------|---------------|----------------------|-------|
| Case Length | Fans Per Case | High Efficiency Fans | |
| | | 120 Volt | |
| | | Amps | Watts |
| 4' | 2 | 0.46 | 36.0 |
| 6' | 4 | 0.95 | 70.0 |
| 8' | 4 | 0.95 | 70.0 |
| 12' | 6 | 1.40 | 106.0 |

| LIGHTING DATA | | | | | |
|---------------|----------------|---|-------|---------------------------|-------|
| Case Length | Lights per row | Clearvoyant v4 LED Lighting (Per Light Row) | | | |
| | | Standard Power (Cornice or Shelf) | | High Power (Cornice Only) | |
| | | 120 Volts | | 120 Volts | |
| | | Amps | Watts | Amps | Watts |
| 4' | 1 | 0.05 | 5.9 | 0.12 | 14.9 |
| 6' | 2 | 0.08 | 9.4 | 0.20 | 23.8 |
| 8' | 2 | 0.10 | 11.8 | 0.25 | 29.9 |
| 12' | 3 | 0.15 | 17.6 | 0.37 | 44.8 |

| GUIDELINES AND CONTROL SETTINGS | | | | | |
|---------------------------------|----------|---------------------------------|-----------------|--------------------|------------------------------|
| BTUH/ft | | Superheat Set Point @ Bulb (°F) | Evaporator (°F) | Discharge Air (°F) | Discharge Air Velocity (FPM) |
| Conventional | Parallel | | | | |
| 1646 | 1440 | 6 - 8 | 26 | 30 | 240 |

| DEFROST CONTROLS | | |
|------------------|-------------------|----------------------|
| Defrosts Per Day | Timed-Off Defrost | |
| | Fail-Safe (Min) | Termination Temp (F) |
| 6 | 40 | 47 |

NOTES

- "----" indicates that the feature is not an option for this case model and/or that the data is not yet available.
- Listed BTUH/ft data represent unlighted shelves. For LED lighting, add 9 BTUH/ft per row of lighted shelving.
- BTUH load increases by 132 BTUH/ft when aftermarket merchandising accessories are utilized.
- Listed evaporator temperature represents unlighted shelves. For lighted shelves and/or aftermarket merchandising accessories, reduce the listed evaporator temperature by 2°F.
- Conventional Discharge Air Control – Recommended Settings: Cut-In Temp = Discharge Air + 2°F; Cut-Out Temp = Discharge Air - 2°F.
- Listed discharge air velocity represents the average velocity immediately after defrost.
- Temperature and defrost settings listed above are recommended start-up settings. Final operational settings may need to be adjusted for the store conditions in which the case operates.
- The recommended evaporator temperatures may need to be adjusted based on system setup, store conditions, etc. The minimum recommended evaporator temperature is 4°F below the listed evaporator temperature.



ON5MHX-NRG

ALL MEASUREMENTS ARE TAKEN PER ASHRAE-72-2005 SPECIFICATIONS. HILLPHOENIX REFRIGERATED DISPLAY CASES FOR SALE IN THE UNITED STATES MEET OR EXCEED DEPARTMENT OF ENERGY 2017 REQUIREMENTS.

| Rev Date: | Rev # | Revision Description: |
|-----------|-------|-----------------------|
| 9-17-18 | 3 | DATA UPDATE |
| 7-9-18 | 2 | NEW STANDARDS |

Hillphoenix
A DOVER COMPANY

ON5MHX-NRG

High Multi-Deck Merchandiser with Synerg-E™
4', 6', 8' & 12' (Deli / Meat)

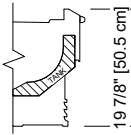
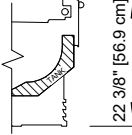
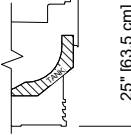
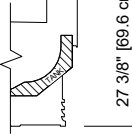
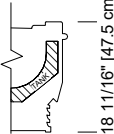
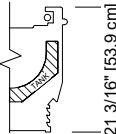
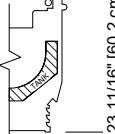
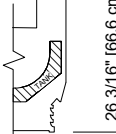
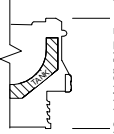
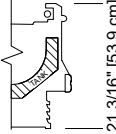
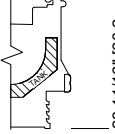
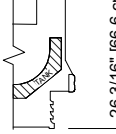
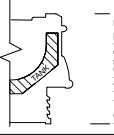
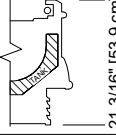
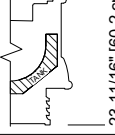
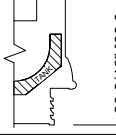
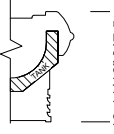
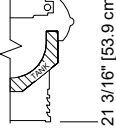
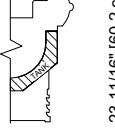
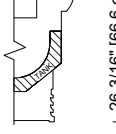
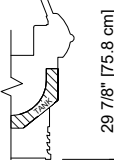
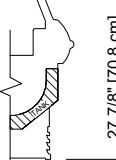
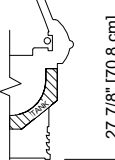
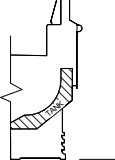
| CORNICHE OPTIONS | | CURVED CORNICHE | CURVED CORNICHE WITH NIGHT COVER | FACETED CORNICHE | FACETED CORNICHE WITH NIGHT COVER | FLAT CORNICHE | FLAT CORNICHE WITH STANDARD NIGHT COVER |
|------------------|-------------------|--|--|---|--|---------------|---|
| | | 37" | 40 1/4" | 36 7/8" | 40 1/8" | 36 1/8" | 38 3/4" |
| FRONT OPTIONS | FLAT FRONT 2 | STANDARD FRONT  | 2 1/2" EXTENDED FRONT W/ & W/O NOSE LIGHT  | 5" EXTENDED FRONT W/ & W/O NOSE LIGHT  | 7 1/2" EXTENDED FRONT  | | |
| | FLAT FRONT | STANDARD FRONT  | 2 1/2" EXTENDED FRONT W/ & W/O NOSE LIGHT  | 5" EXTENDED FRONT W/ & W/O NOSE LIGHT  | 7 1/2" EXTENDED FRONT  | | |
| | CLASSIC 2 METAL | STANDARD FRONT  | 2 1/2" EXTENDED FRONT W/ & W/O NOSE LIGHT  | 5" EXTENDED FRONT W/ & W/O NOSE LIGHT  | 7 1/2" EXTENDED FRONT  | | |
| | CLASSIC 2 POLYMER | STANDARD FRONT  | 2 1/2" EXTENDED FRONT W/ & W/O NOSE LIGHT  | 5" EXTENDED FRONT W/ & W/O NOSE LIGHT  | 7 1/2" EXTENDED FRONT  | | |
| | ORIGIN 2 | STANDARD FRONT  | 2 1/2" EXTENDED FRONT W/ & W/O NOSE LIGHT  | 5" EXTENDED FRONT W/ & W/O NOSE LIGHT  | 7 1/2" EXTENDED FRONT  | | |
| | THERMOPANE | 6" THERMOPANE FRONT  | 4" THERMOPANE FRONT  | 4" THERMOPANE FRONT W/T NOSE LIGHT  | 6" THERMOPANE FRONT  | | |

NOTES

- Front sill height and overall case height varies with base frame height.



COMPONENT

ALL MEASUREMENTS ARE TAKEN PER ASHRAE-72-2005 SPECIFICATIONS. HILLPHOENIX REFRIGERATED DISPLAY CASES FOR SALE IN THE UNITED STATES MEET OR EXCEED DEPARTMENT OF ENERGY 2017 REQUIREMENTS.

ON5MHX-NRG

| Rev Date: | Rev # | Revision Description: |
|-----------|-------|-----------------------|
| 9-17-18 | 3 | DATA UPDATE |
| 7-9-18 | 2 | NEW STANDARDS |

Hillphoenix

A DOVER COMPANY

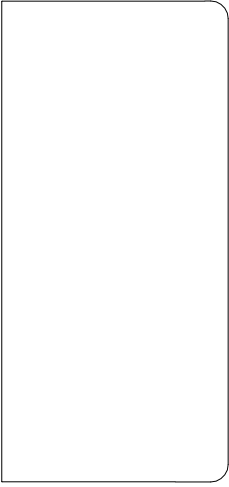
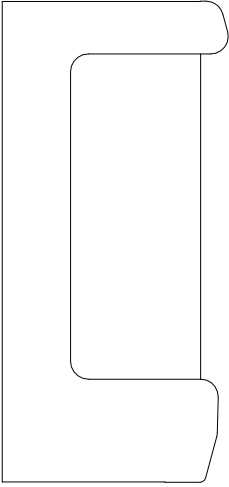
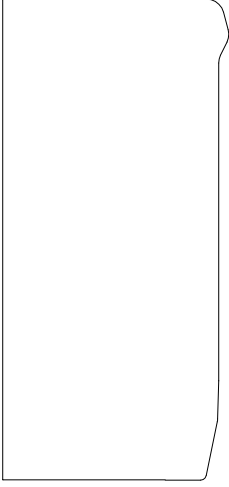
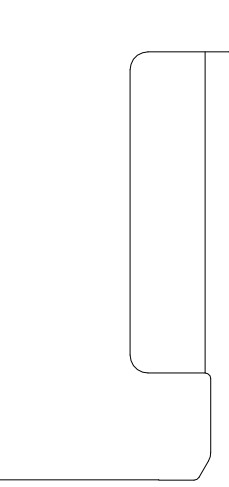
| END OPTIONS | |
|---|---|
| <u>SQUARE</u> | <u>FULL VIEW</u> |
|  |  |
| <u>SOLID</u> | <u>REDUCED VIEW</u> |
|  |  |



COMPONENT

ALL MEASUREMENTS ARE TAKEN PER ASHRAE-72-2005 SPECIFICATIONS. HILLPHOENIX REFRIGERATED DISPLAY CASES FOR SALE IN THE UNITED STATES MEET OR EXCEED DEPARTMENT OF ENERGY 2017 REQUIREMENTS.

ON5MHX-NRG

| Rev Date: | Rev # | Revision Description: |
|-----------|-------|-----------------------|
| 9-5-18 | 1 | ENDS SELECTION |
| | | |

Hillphoenix

A DOVER COMPANY

ON5MHX-NRG

High Multi-Deck Merchandiser with Synerg-E™
4', 6', 8' & 12' (Deli / Meat)

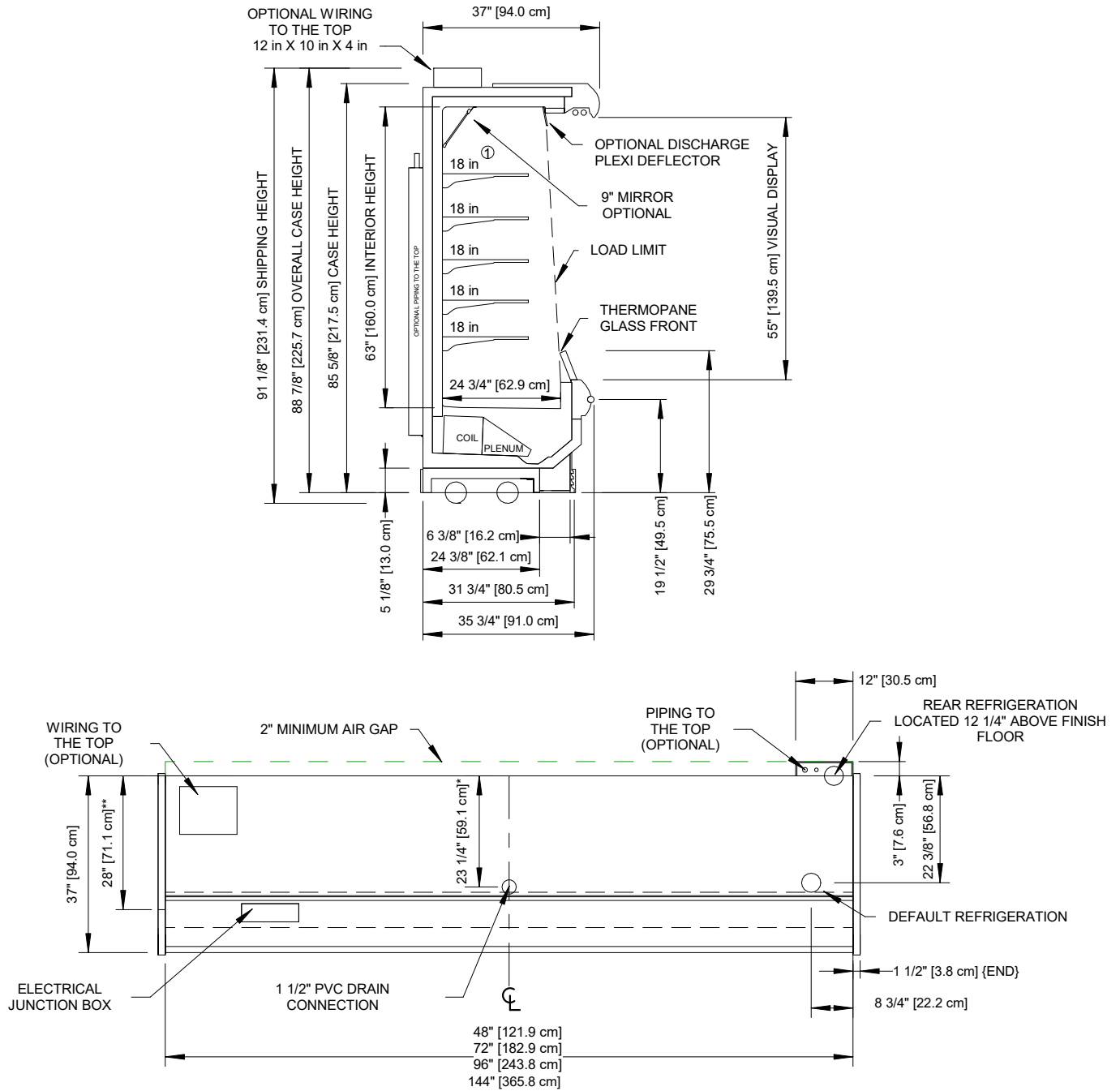

NOTES

- * : STUB-UP AREA
- ** : RECOMMENDED STUB-UP CENTERLINE FOR ELECTRICAL AND DRAINS
- ① : AVAILABLE SHELF SIZES: 10", 12", 14", 16", & 18"

• Ends add approximately 1" to case height, 1/2" to the back and 1" to the front.



ALL MEASUREMENTS ARE TAKEN PER ASHRAE-72-2005 SPECIFICATIONS. HILLPHOENIX REFRIGERATED DISPLAY CASES FOR SALE IN THE UNITED STATES MEET OR EXCEED DEPARTMENT OF ENERGY 2017 REQUIREMENTS.

ON5MHX-NRG

| Rev Date: | Rev # | Revision Description: |
|-----------|-------|-----------------------|
| 9-17-18 | 3 | DATA UPDATE |
| 7-9-18 | 2 | NEW STANDARDS |

