

O3UD-NRG

Multi-Deck Merchandiser with Synerg-E™
4', 6', 8' & 12' (Dairy/Deli/Produce/Meat)

GENERAL NOTES

- "---" indicates that the feature is not an option for this case model and/or the data is not yet available.
- LED lights only.
- Maximum of 2 rows of standard output LED lighted shelves.
- Nose lights are not available.

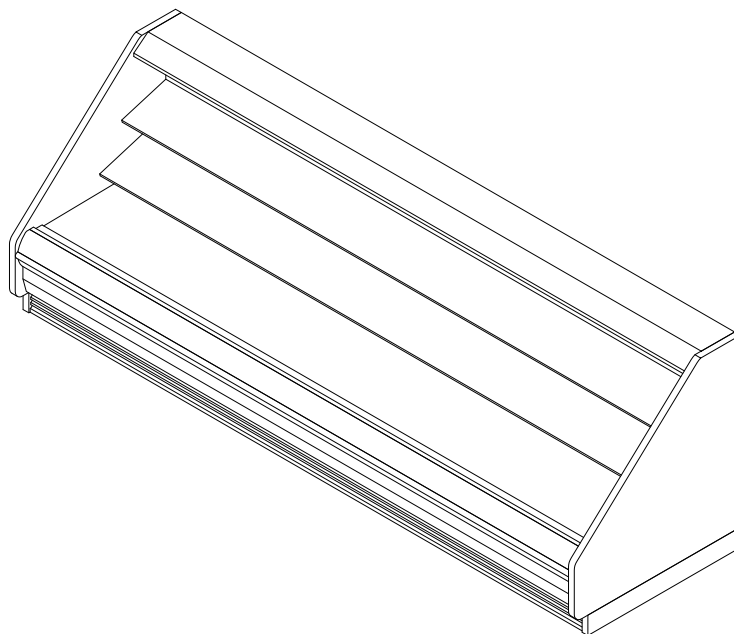

SHIPPING WEIGHT	
Case	Weight
O3UD-NRG	---



ALL MEASUREMENTS ARE TAKEN PER ASHRAE-72-2005 SPECIFICATIONS. HILLPHOENIX REFRIGERATED DISPLAY CASES FOR SALE IN THE UNITED STATES MEET OR EXCEED DEPARTMENT OF ENERGY 2017 REQUIREMENTS.

O3UD-NRG

Rev Date:	Rev #	Revision Description:
9-7-18	3	DATA UPDATE
5-22-18	2	NEW STANDARDS

Hillphoenix
A BOWEN COMPANY

O3UD-NRG

Multi-Deck Merchandiser with Synerg-E™
4', 6', 8' & 12' (Dairy/Deli/Produce/Meat)

ELECTRICAL DATA			
Case Length	Fans Per Case	High Efficiency Fans	
		120 Volts	
		Amps	Watts
4'	1	0.16	11.0
6'	2	0.32	22.0
8'	2	0.32	22.0
12'	3	0.48	33.0

LIGHTING DATA						
Case Length	Lights per row	Lights Length	Clearvoyant LED Lighting (Per Light Row)			
			Standard Power (Cornice or Shelf)		High Power (Cornice)	
			120 Volts		120 Volts	
			Amps	Watts	Amps	Watts
4'	1	4'	0.05	5.9	0.12	14.9
6'	2	3'	0.08	9.4	0.20	23.8
8'	2	4'	0.10	11.8	0.25	29.9
12'	3	4'	0.15	17.6	0.37	44.8

GUIDELINES AND CONTROL SETTINGS							
Application	Front Sill Height	BTUH/ft		Superheat Set Point @ Bulb (°F)	Evaporator (°F)	Discharge Air (°F)	Discharge Air Velocity (FPM)
		Conventional	Parallel				
Dairy/Deli/Produce	All	926	810	6 - 8	28	31	180
Meat	Extended	915	800	6 - 8	26	30	180

DEFROST CONTROLS		
Defrosts Per Day	Timed-Off Defrost	
	Fail-Safe (Min)	Termination Temp (°F)
6	30	47

NOTES

- "---" indicates that the feature is not an option for this case model and/or the data is not yet available.
- Listed BTUH/ft data represent unlighted shelves. For LED lighting, add 9 BTUH/ft per row of lighted shelving. BTUH load increases by 132 BTUH/ft when aftermarket merchandising accessories are utilized.
- Listed evaporator temperature represents unlighted shelves. For lighted shelves and/or aftermarket merchandising accessories, reduce the listed evaporator temperature by 2°F.
- Conventional Discharge Air Control – Recommended Settings: Cut-In Temp = Discharge Air + 2°F; Cut-Out Temp = Discharge Air - 2°F.
- Listed discharge air velocity represents the average velocity immediately after defrost.
- Temperature and defrost settings listed above are recommended start-up settings. Final operational settings may need to be adjusted for the store conditions in which the case operates.
- The recommended evaporator temperatures may need to be adjusted based on system setup, store conditions, etc. The minimum recommended evaporator temperature is 4°F below the listed evaporator temperature.



ALL MEASUREMENTS ARE TAKEN PER ASHRAE-72-2005 SPECIFICATIONS. HILLPHOENIX REFRIGERATED DISPLAY CASES FOR SALE IN THE UNITED STATES MEET OR EXCEED DEPARTMENT OF ENERGY 2017 REQUIREMENTS.





O3UD-NRG

Rev Date:	Rev #	Revision Description:
9-7-18	3	DATA UPDATE
5-22-18	2	NEW STANDARDS

Hillphoenix
A BOWEN COMPANY

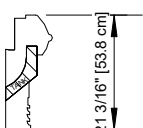
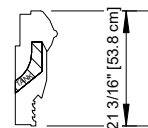
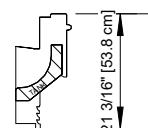
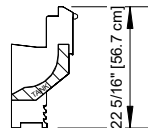
O3UD-NRG

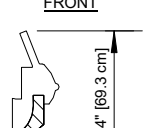
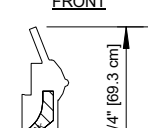
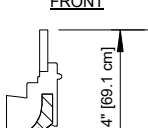
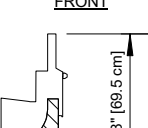
Multi-Deck Merchandiser with Synerg-E™
4', 6', 8' & 12' (Dairy/Deli/Produce/Meat)

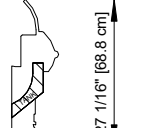
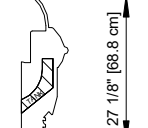
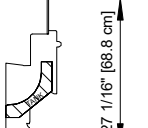
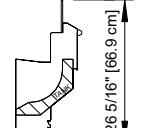
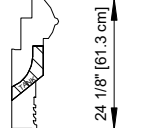
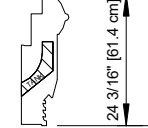
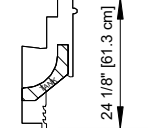
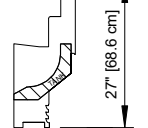
REAR SILL OPTIONS	FRONT OPTIONS			
	ORIGIN 2 FRONT	FLAT FRONT FLAT TOP	FLAT FRONT ANGLED TOP	
STANDARD REAR SILL  8 9/16" [21.7 cm]	STANDARD FRONT  21 3/16" [53.8 cm]	STANDARD FRONT  21 3/16" [53.8 cm]	STANDARD FRONT  21 3/16" [53.8 cm]	STANDARD FRONT  22.5/16" [56.7 cm]
12 1/2" REAR SILL  12 7/16" [31.7 cm]	6" THERMOPANE FRONT  27 1/4" [69.3 cm]	6" THERMOPANE FRONT  27 1/4" [69.3 cm]	6" THERMOPANE FRONT  27 1/4" [69.1 cm]	6" THERMOPANE FRONT  27 3/8" [69.5 cm]
16" REAR SILL (REAR DISCHARGE)  16 1/16" [40.7 cm]	6" PLEXIGLAS FRONT  27 1/16" [68.8 cm]	6" PLEXIGLAS FRONT  27 1/8" [68.8 cm]	6" PLEXIGLAS FRONT  27 1/16" [68.8 cm]	6" PLEXIGLAS FRONT  26.5/16" [66.9 cm]
	EXTENDED STANDARD FRONT  24 1/8" [61.3 cm]	EXTENDED STANDARD FRONT  24 3/16" [61.4 cm]	EXTENDED STANDARD FRONT  24 1/8" [61.3 cm]	EXTENDED STANDARD FRONT  27" [68.6 cm]

NOTES:

- Front and rear sill heights vary with base frame height.



ALL MEASUREMENTS ARE TAKEN PER ASHRAE-72-2005 SPECIFICATIONS. HILLPHOENIX REFRIGERATED DISPLAY CASES FOR SALE IN THE UNITED STATES MEET OR EXCEED DEPARTMENT OF ENERGY 2017 REQUIREMENTS.

O3UD-NRG

Rev Date:	Rev #	Revision Description:
9-7-18	3	DATA UPDATE
5-22-18	2	NEW STANDARDS

Hillphoenix
A BOWEN COMPANY

O3UD-NRG

Multi-Deck Merchandiser with Synerg-E™
4', 6', 8' & 12' (Dairy/Deli/Produce/Meat)

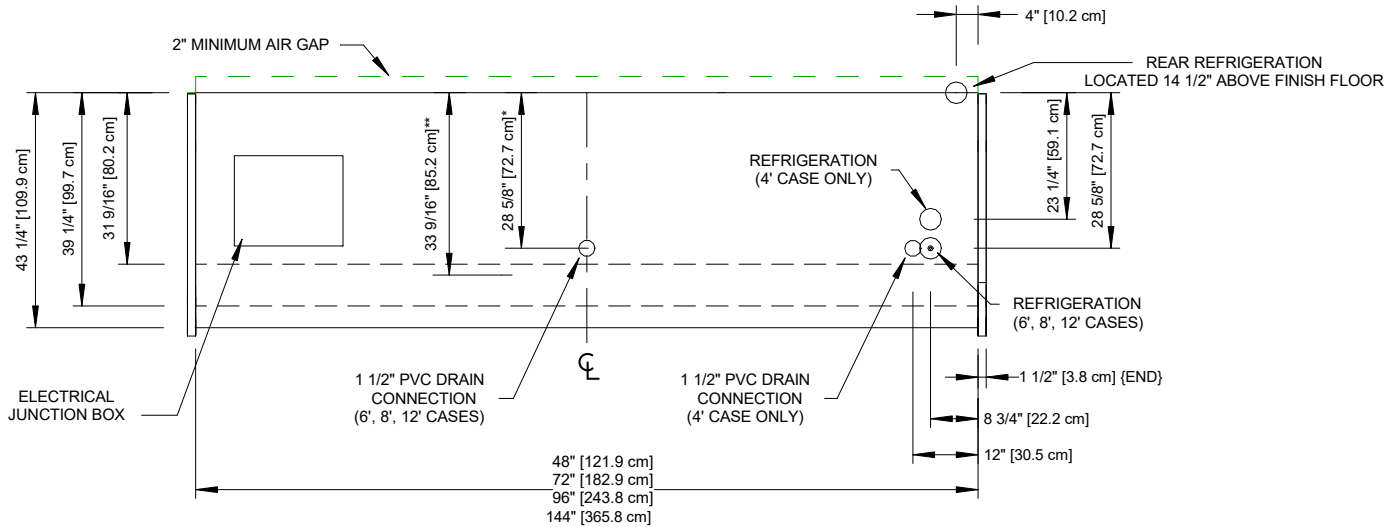
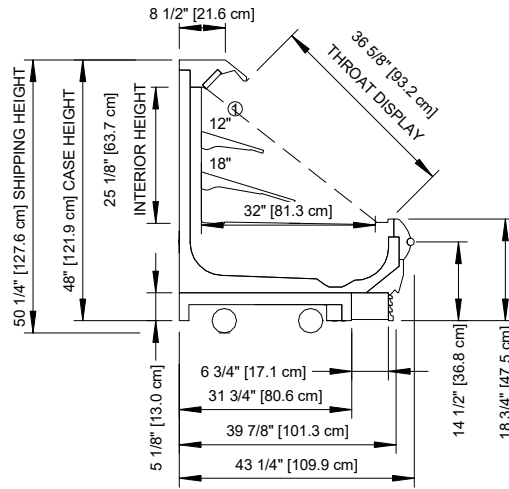

NOTES

- * :STUB-UP AREA
- ** :RECOMMENDED STUB-UP CENTERLINE FOR ELECTRICAL AND HUB DRAINS
- ① :AVAILABLE SHELF SIZES: 10", 12", 14", 16", & 18"

- Ends add approximately 1" to case height, 1" to the front and 1/2" to the back.



ALL MEASUREMENTS ARE TAKEN PER ASHRAE-72-2005 SPECIFICATIONS. HILLPHOENIX REFRIGERATED DISPLAY CASES FOR SALE IN THE UNITED STATES MEET OR EXCEED DEPARTMENT OF ENERGY 2017 REQUIREMENTS.

O3UD-NRG

Rev Date:	Rev #	Revision Description:
9-7-18	3	DATA UPDATE
5-22-18	2	NEW STANDARDS

Hillphoenix
A BOWEN COMPANY