

# O3.75UM-NRG

Multi-Deck Merchandiser with Synerg-E™  
4', 6', 8', 12' Dairy/Deli/Meat/Produce

## GENERAL NOTES:

- "---" indicates that the feature is not an option with this case model and/or the data is not available at this time.
- LED lights only.
- Nose lights are not available.

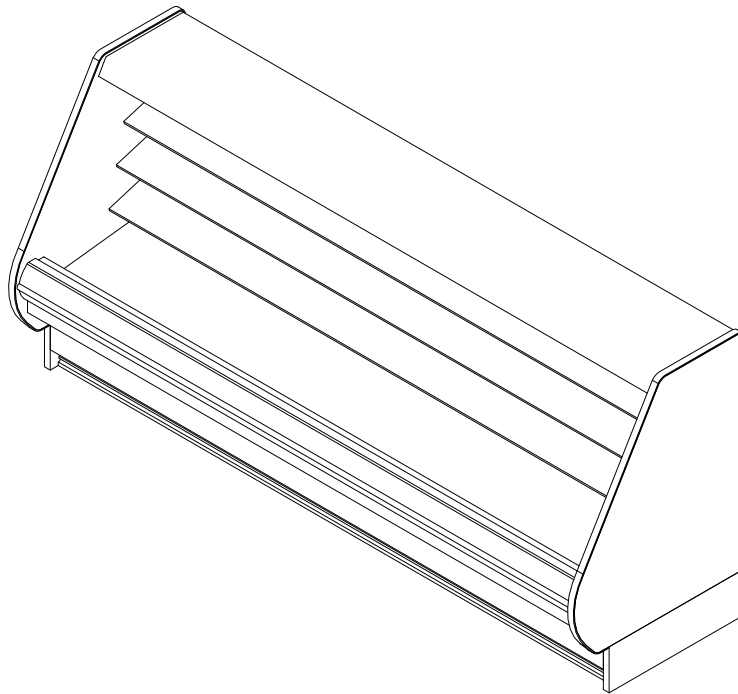

SHIPPING WEIGHT	
Case	Weight
O3.75UM-NRG	---



COMPONENT  
ALL MEASUREMENTS ARE TAKEN PER  
ASHRAE-72-2005 SPECIFICATIONS. HILLPHOENIX  
REFRIGERATED DISPLAY CASES FOR SALE IN THE  
UNITED STATES MEET OR EXCEED DEPARTMENT  
OF ENERGY 2017 REQUIREMENTS.

## O3.75UM-NRG

Rev Date:	Rev #	Revision Description:
5/15/18	2	NEW STANDARDS
5/3/17	1	DOE 2017

**Hillphoenix**  
A BOWEN COMPANY

# O3.75UM-NRG

Multi-Deck Merchandiser with Synerg-E™  
4', 6', 8', 12' Dairy/Deli/Meat/Produce

ELECTRICAL DATA			
Case Length	Fans Per Case	High Efficiency Fans	
		120 Volts	
		Amps	Watts
4'	1	0.20	14.0
6'	2	0.40	28.0
8'	2	0.40	28.0
12'	3	0.60	42.0

LIGHTING DATA						
Case Length	Lights Per Row	Light Length	CL4 LED Lighting (Per Light Row)			
			Standard Power		High Power Power	
			Cornice or Shelf		Cornice Only	
			120 Volts		120 Volts	
			Amps	Watts	Amps	Watts
4'	1	4'	0.05	5.9	0.12	14.9
6'	2	3'	0.08	9.4	0.20	23.8
8'	2	4'	0.10	11.8	0.25	29.9
12'	3	4'	0.15	17.6	0.37	44.8

GUIDLINES AND CONTROL SETTINGS							
Application	Front Sill Height	BTUH/ft		Super Heat Set Point @ Bulb (°F)	Evaporator (°F)	Discharge Air (°F)	Discharge Air Velocity (FPM)
		Conventional	Parallel				
Dairy / Deli / Produce	All	1063	930	6 - 8	28	31	180
Meat	Extended	1051	920	6 - 8	28	30	180

DEFROST CONTROLS		
Defrost Per Day	Timed - Off Defrost	
	Fail-Safe (Min)	Termination Temp (°F)
6	30	42

## NOTES:

- "----" indicates that the feature is not an option with this case model and/or the data is not available at this time.
- Listed anti-condensate heater data represent an unlighted rear sill.
- Listed BTUH/ft data represent unlighted shelves. For LED lighting, add 9 BTUH/ft per row of lighted shelving.
- Listed discharge air velocity represents the average velocity at the peak of defrost.
- Temperature and defrost settings listed above are recommended start-up settings. Final operational settings may need to be adjusted for the store conditions in which the case operates.
- The recommended evaporator temperatures may need to be adjusted based on system setup, store conditions, etc. The minimum recommended evaporator temperature is 4°F below the listed evaporator temperature.
- Timed off defrost is recommended for medium temperature applications.



ALL MEASUREMENTS ARE TAKEN PER ASHRAE-72-2005 SPECIFICATIONS. HILLPHOENIX REFRIGERATED DISPLAY CASES FOR SALE IN THE UNITED STATES MEET OR EXCEED DEPARTMENT OF ENERGY 2017 REQUIREMENTS.

## O3.75UM-NRG

Rev Date:	Rev #	Revision Description:
5/15/18	2	NEW STANDARDS
5/3/17	1	DOE 2017

**Hillphoenix**  
A BOWEN COMPANY

# O3.75UM-NRG

Multi-Deck Merchandiser with Synerg-E™  
4', 6', 8', 12' Dairy/Deli/Meat/Produce

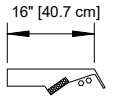
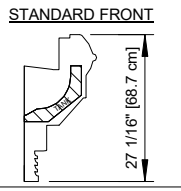
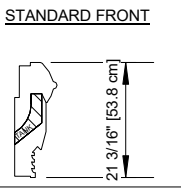
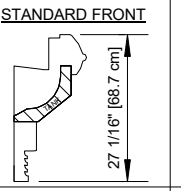
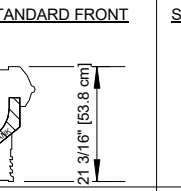
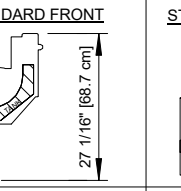
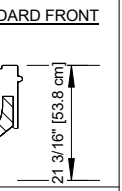
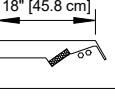
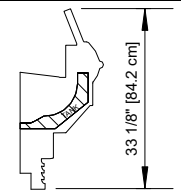
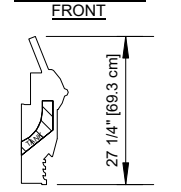
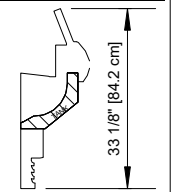
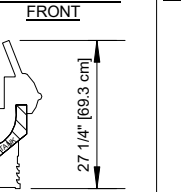
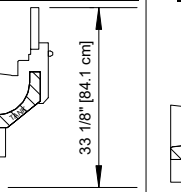
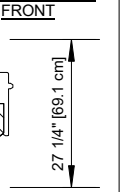
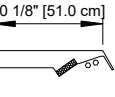
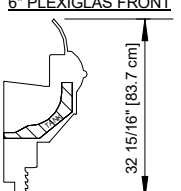
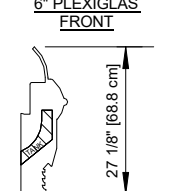
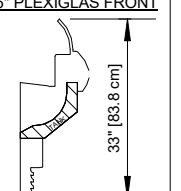
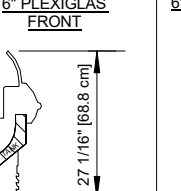
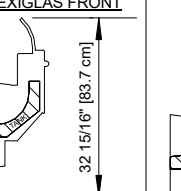
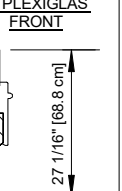
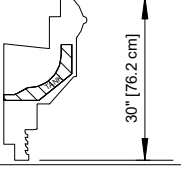
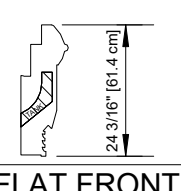
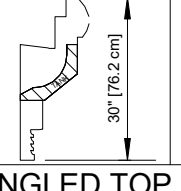
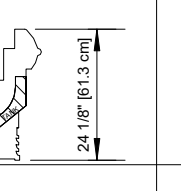
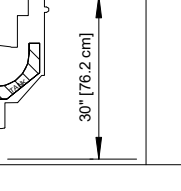
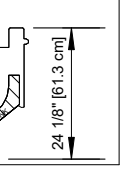
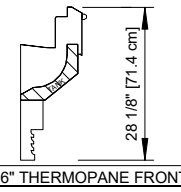
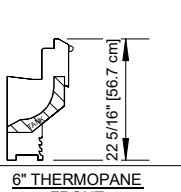
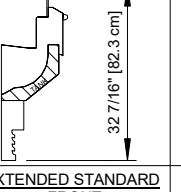
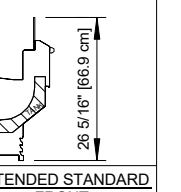
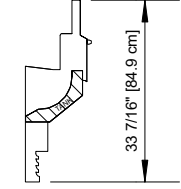
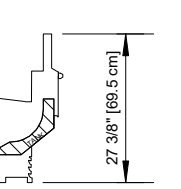
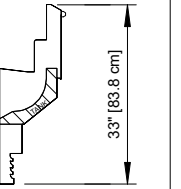
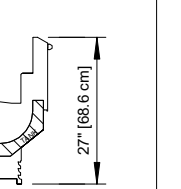
REAR SILL OPTIONS	FRONT OPTIONS					
	ORIGIN 2 FRONT				FLAT FRONT FLAT TOP	
	STANDARD FRONT	STANDARD FRONT	STANDARD FRONT	STANDARD FRONT	STANDARD FRONT	STANDARD FRONT
<b>16" REAR SILL (FRONT DISCHARGE)</b>  16" [40.7 cm]	 27 1/16" [68.7 cm]	 21 3/16" [53.8 cm]	 27 1/16" [68.7 cm]	 21 3/16" [53.8 cm]	 27 1/16" [68.7 cm]	 21 3/16" [53.8 cm]
<b>18" REAR SILL (FRONT DISCHARGE)</b>  18" [45.8 cm]	 33 1/8" [84.2 cm]	 27 1/4" [69.3 cm]	 33 1/8" [84.2 cm]	 27 1/4" [69.3 cm]	 33 1/8" [84.1 cm]	 27 1/4" [69.1 cm]
<b>20" REAR SILL (FRONT DISCHARGE)</b>  20 1/8" [51.0 cm]	 32 15/16" [83.7 cm]	 27 1/8" [68.8 cm]	 33" [83.8 cm]	 27 1/16" [68.8 cm]	 32 15/16" [83.7 cm]	 27 1/16" [68.8 cm]
	<b>EXTENDED STANDARD FRONT</b>  30" [76.2 cm]	<b>EXTENDED STANDARD FRONT</b>  24 3/16" [61.4 cm]	<b>EXTENDED STANDARD FRONT</b>  30" [76.2 cm]	<b>EXTENDED STANDARD FRONT</b>  24 1/8" [61.3 cm]	<b>EXTENDED STANDARD FRONT</b>  30" [76.2 cm]	<b>EXTENDED STANDARD FRONT</b>  24 1/8" [61.3 cm]
	FLAT FRONT ANGLED TOP					
	<b>STANDARD FRONT</b>  28 1/8" [71.4 cm]	<b>STANDARD FRONT</b>  22 5/16" [56.7 cm]	<b>6" PLEXIGLAS FRONT</b>  32 7/16" [82.3 cm]	<b>6" PLEXIGLAS FRONT</b>  26 5/16" [66.9 cm]		
	<b>6" THERMOPANE FRONT</b>  33 7/16" [84.9 cm]	<b>6" THERMOPANE FRONT</b>  27 3/8" [69.5 cm]	<b>EXTENDED STANDARD FRONT</b>  33" [83.8 cm]	<b>EXTENDED STANDARD FRONT</b>  27" [68.6 cm]		

**NOTES:**

- Front and rear sill height vary with basframe height.
- Extended front sills are required for meat applications to maintain proper product temperature. An extended front has a minimum height of 24" on a 5" baseframe, or 30" on an 11" baseframe.



**O3.75UM-NRG**

ALL MEASUREMENTS ARE TAKEN PER ASHRAE-72-2005 SPECIFICATIONS. HILLPHOENIX REFRIGERATED DISPLAY CASES FOR SALE IN THE UNITED STATES MEET OR EXCEED DEPARTMENT OF ENERGY 2017 REQUIREMENTS.

Rev Date:	Rev #	Revision Description:
5/15/18	2	NEW STANDARDS
5/3/17	1	DOE 2017



A BOWEN COMPANY

# O3.75UM-NRG

Multi-Deck Merchandiser with Synerg-E™  
4', 6', 8', 12' Dairy/Deli/Meat/Produce

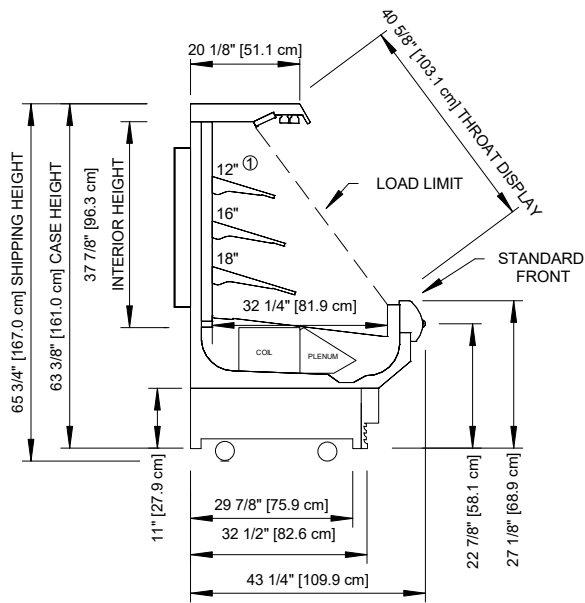

**11" BASEFRAME**

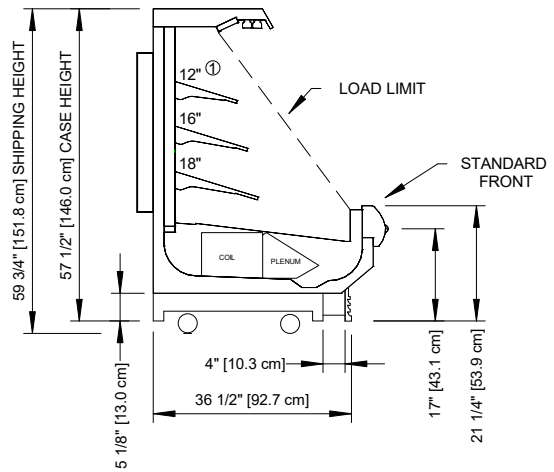

**5" BASEFRAME**

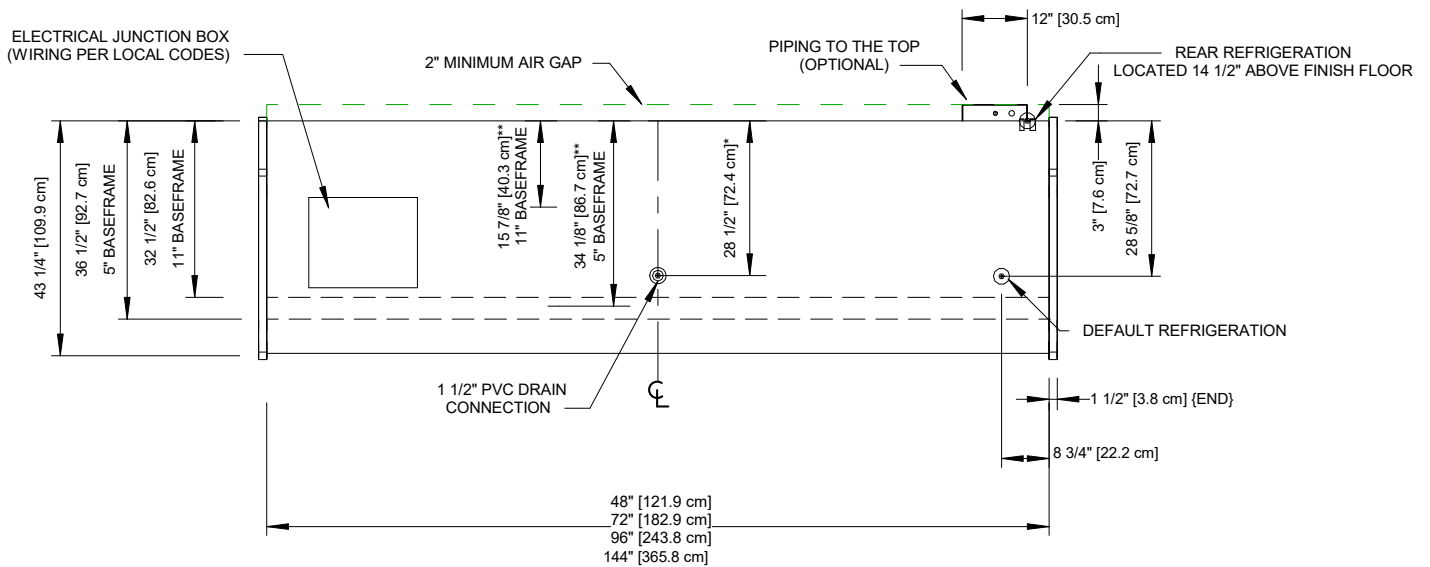

**NOTES**

- \* :STUB-UP AREA
- \*\* :RECOMMENDED STUB-UP CENTERLINE FOR ELECTRICAL AND HUB DRAINS
- ① :AVAILABLE SHELF SIZES: 10", 12", 14", 16", & 18"

- Ends add approximately 1" to case height, 1" to case height and 1/2" to the back.
- Product on top shelf should be 3" below discharge.
- Dashed lines signify area inside base rail behind kick plate.



**O3.75UM-NRG**

ALL MEASUREMENTS ARE TAKEN PER ASHRAE-72-2005 SPECIFICATIONS. HILLPHOENIX REFRIGERATED DISPLAY CASES FOR SALE IN THE UNITED STATES MEET OR EXCEED DEPARTMENT OF ENERGY 2017 REQUIREMENTS.

Rev Date:	Rev #	Revision Description:
5/15/18	2	NEW STANDARDS
5/3/17	1	DOE 2017

