

# ON4UM-NRG

Narrow Multi-Deck Merchandiser  
4', 6', 8', 12' (Dairy/Deli/Produce)

## GENERAL NOTES

- "---" indicates that the feature is not an option with this case model and/or the data is not available at this time.

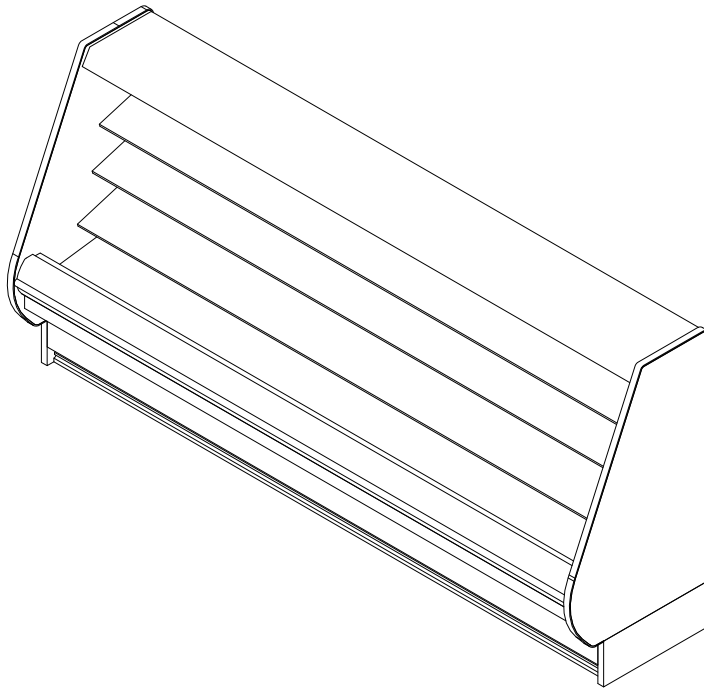

SHIPPING WEIGHT	
Case	Weight
ON4UM-NRG	---



ALL MEASUREMENTS ARE TAKEN PER ASHRAE-72-2005 SPECIFICATIONS. HILLPHOENIX REFRIGERATED DISPLAY CASES FOR SALE IN THE UNITED STATES MEET OR EXCEED DEPARTMENT OF ENERGY 2017 REQUIREMENTS.

## ON4UM-NRG

Rev. Date	Rev. #	Rev. Title
9-11-18	3	DATA UPDATE
8-1-18	2	NEW STANDARDS

**Hillphoenix**  
A DOVER COMPANY

# ON4UM-NRG

Narrow Multi-Deck Merchandiser  
4', 6', 8', 12' (Dairy/Deli/Produce)

ELECTRICAL DATA			
Case Length	Fans Per Case	High Efficiency Fans	
		120 Volts	
		Amps	Watts
4'	1	0.16	11.0
6'	2	0.32	22.0
8'	2	0.32	22.0
12'	3	0.48	33.0

LIGHTING DATA						
Case Length	Lights per row	Lights Length	Clearvoyant LED Lighting (Per Light Row)			
			Standard Power (Cornice or Shelf)		High Power (Cornice)	
			120 Volts		120 Volts	
			Amps	Watts	Amps	Watts
4'	1	4'	0.05	5.9	0.12	14.9
6'	2	3'	0.08	9.4	0.20	23.8
8'	2	4'	0.10	11.8	0.25	29.8
12'	3	4'	0.15	17.7	0.37	44.7

GUIDELINES AND CONTROL SETTINGS							
Application	Front Sill Height	BTUH/ft		Superheat Set Point @ Bulb (°F)	Evaporator (°F)	Discharge Air (°F)	Discharge Air Velocity (FPM)
		Conventional	Parallel				
Dairy/Deli/Produce	All	1175	1070	6 - 8	28	31	180

DEFROST CONTROLS		
Defrosts Per Day	Timed-Off Defrost	
	Fail-Safe (Min)	Termination Temp (°F)
6	30	47

## NOTES:

- Listed BTUH/ft data represent unlighted shelves. For LED lighting, add 9 BTUH/ft per row of lighted shelving.
- BTUH load increases by 123 BTUH/ft when aftermarket merchandising accessories are utilized.
- Listed evaporator temperature represents unlighted shelves. For lighted shelves and/or aftermarket merchandising accessories, reduce the listed evaporator temperature by 2°F.
- Conventional Discharge Air Control - Recommended Settings: Cut-in Temp + Discharge Air + 2°F; Cut-Out Temp = Discharge Air - 2°F.
- Listed discharge air velocity represents the average velocity immediately after defrost.
- Temperature and defrost settings listed above are recommended start-up settings. Final operational settings may need to be adjusted for the store conditions in which the case operates.
- The recommended evaporator temperatures may need to be adjusted based on system setup, store conditions, etc. The minimum recommended evaporator temperature is 4°F below the listed evaporator temperature.



ALL MEASUREMENTS ARE TAKEN PER ASHRAE-72-2005 SPECIFICATIONS. HILLPHOENIX REFRIGERATED DISPLAY CASES FOR SALE IN THE UNITED STATES MEET OR EXCEED DEPARTMENT OF ENERGY 2017 REQUIREMENTS.

## ON4UM-NRG

Rev. Date	Rev. #	Rev. Title
9-11-18	3	DATA UPDATE
8-1-18	2	NEW STANDARDS

**Hillphoenix**  
A DOVER COMPANY

# ON4UM-NRG

Narrow Multi-Deck Merchandiser  
4', 6', 8', 12' (Dairy/Deli/Produce)

SECOND NATURE DATA								
Case Model	No. of Coils	Application	Front Sill Type	BTUH/FT (DR)		GPM/ft (DR)	Supply Fluid Temp (°F)	Discharge Air Temp (°F)
				Conventional	Parallel			
ON4UM-NRG	1	Deli/Produce	All Fronts	1015	930	0.26	20	31
ON4UM-NRG	1	Deli/Produce	All Fronts	1015	930	0.67	25	31

SECOND NATURE DATA								
Case Model	No. of Coils	Application	Front Sill Type	No. of Defrost	Timed-Off Defrost		Warm Fluid Defrost	
					Fail Safe (Min)	Termination Temp (°F)	Fail Safe (Min)	Termination Temp (°F)
ON4UM-NRG	1	Deli/Produce	All Fronts	6	60	47	26	49
ON4UM-NRG	1	Deli/Produce	All Fronts	6	60	47	26	49



ALL MEASUREMENTS ARE TAKEN PER ASHRAE-72-2005 SPECIFICATIONS. HILLPHOENIX REFRIGERATED DISPLAY CASES FOR SALE IN THE UNITED STATES MEET OR EXCEED DEPARTMENT OF ENERGY 2017 REQUIREMENTS.

## ON4UM-NRG





Rev. Date	Rev. #	Rev. Title
9-11-18	3	DATA UPDATE
8-1-18	2	NEW STANDARDS

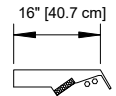
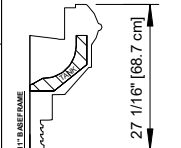
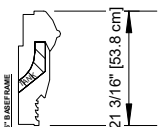
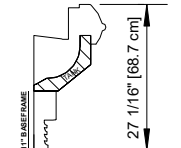
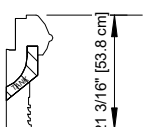
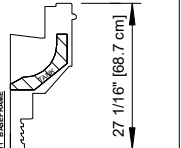
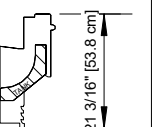
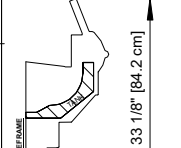
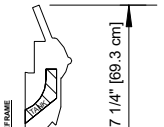
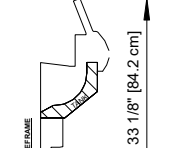
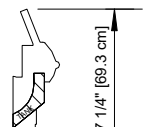
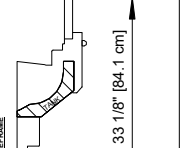
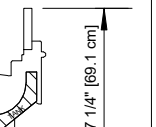
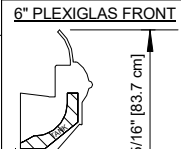
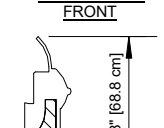
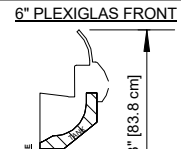
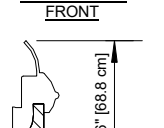
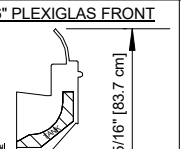
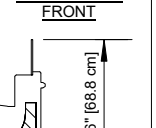
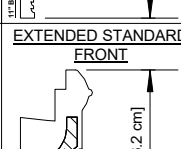
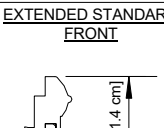
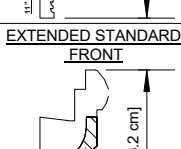
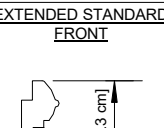
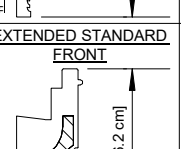
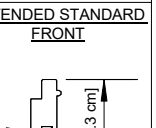
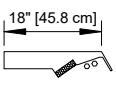
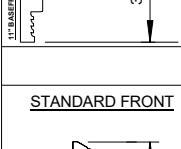

A DOVER COMPANY

# ON4UM-NRG

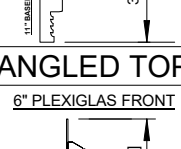
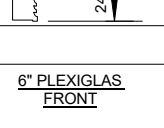
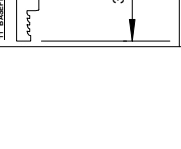
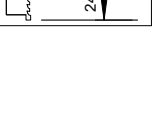
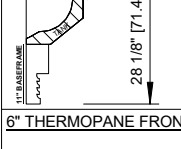
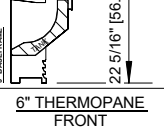
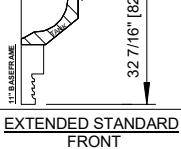
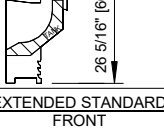
Narrow Multi-Deck Merchandiser  
4', 6', 8', 12' (Dairy/Deli/Produce)

REAR SILL OPTIONS	FRONT OPTIONS					
	ORIGIN 2 FRONT				FLAT FRONT FLAT TOP	
	STANDARD FRONT	STANDARD FRONT	STANDARD FRONT	STANDARD FRONT	STANDARD FRONT	STANDARD FRONT
<b>16" REAR SILL (FRONT DISCHARGE)</b>  						
	27 1/16" [68.7 cm]	21 3/16" [53.8 cm]	27 1/16" [68.7 cm]	21 3/16" [53.8 cm]	27 1/16" [68.7 cm]	21 3/16" [53.8 cm]
	<b>6" THERMOPANE FRONT</b>	<b>6" THERMOPANE FRONT</b>	<b>6" THERMOPANE FRONT</b>	<b>6" THERMOPANE FRONT</b>	<b>6" THERMOPANE FRONT</b>	<b>6" THERMOPANE FRONT</b>
						
	33 1/8" [84.2 cm]	27 1/4" [69.3 cm]	33 1/8" [84.2 cm]	27 1/4" [69.3 cm]	33 1/8" [84.1 cm]	27 1/4" [69.1 cm]
	<b>6" PLEXIGLAS FRONT</b>	<b>6" PLEXIGLAS FRONT</b>	<b>6" PLEXIGLAS FRONT</b>	<b>6" PLEXIGLAS FRONT</b>	<b>6" PLEXIGLAS FRONT</b>	<b>6" PLEXIGLAS FRONT</b>
						
	32 15/16" [83.7 cm]	27 7/8" [68.8 cm]	33" [83.8 cm]	27 1/16" [68.8 cm]	32 15/16" [83.7 cm]	27 1/16" [68.8 cm]
	<b>EXTENDED STANDARD FRONT</b>	<b>EXTENDED STANDARD FRONT</b>	<b>EXTENDED STANDARD FRONT</b>	<b>EXTENDED STANDARD FRONT</b>	<b>EXTENDED STANDARD FRONT</b>	<b>EXTENDED STANDARD FRONT</b>
						
	30" [76.2 cm]	24 3/16" [61.4 cm]	30" [76.2 cm]	24 1/8" [61.3 cm]	30" [76.2 cm]	24 1/8" [61.3 cm]
	<b>20" REAR SILL (FRONT DISCHARGE)</b>  					
						
	28 1/8" [71.4 cm]	22 5/16" [56.7 cm]	32 7/16" [82.3 cm]	26 5/16" [66.9 cm]	28 1/8" [71.4 cm]	22 5/16" [56.7 cm]
	<b>6" THERMOPANE FRONT</b>	<b>6" THERMOPANE FRONT</b>	<b>EXTENDED STANDARD FRONT</b>	<b>EXTENDED STANDARD FRONT</b>	<b>6" THERMOPANE FRONT</b>	<b>6" THERMOPANE FRONT</b>
						
	33 7/16" [84.9 cm]	27 3/8" [69.5 cm]	33" [83.8 cm]	27" [68.6 cm]	33 7/16" [84.9 cm]	27 3/8" [69.5 cm]

**NOTES:**

- Front and rear sill heights vary with base frame height.



ALL MEASUREMENTS ARE TAKEN PER ASHRAE-72-2005 SPECIFICATIONS. HILLPHOENIX REFRIGERATED DISPLAY CASES FOR SALE IN THE UNITED STATES MEET OR EXCEED DEPARTMENT OF ENERGY 2017 REQUIREMENTS.

**ON4UM-NRG**

Rev. Date	Rev. #	Rev. Title
9-11-18	3	DATA UPDATE
8-1-18	2	NEW STANDARDS



A DOVER COMPANY

# ON4UM-NRG

Narrow Multi-Deck Merchandiser  
4', 6', 8', 12' (Dairy/Deli/Produce)

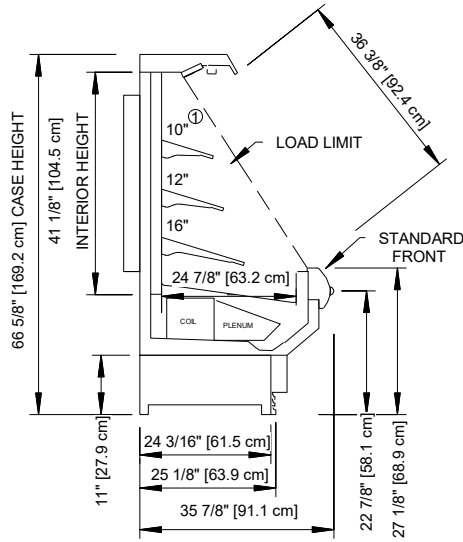

**11" BASEFRAME**

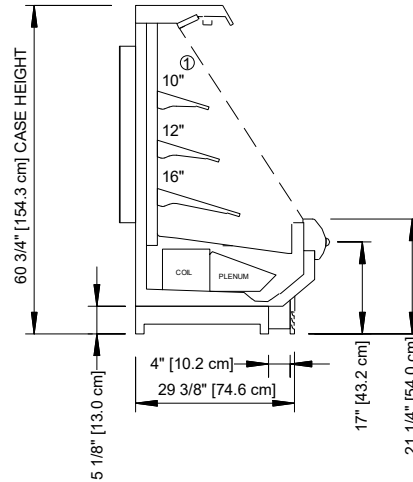

**5" BASEFRAME**

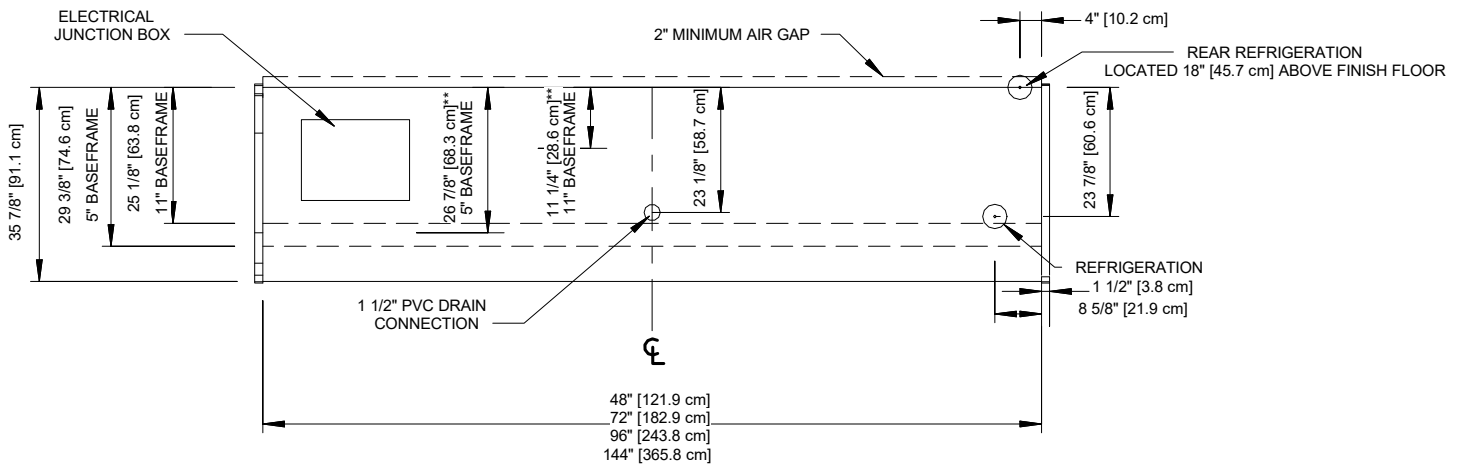

**NOTES:**

- \* :STUB-UP AREA
- \*\* :RECOMMENDED STUB-UP CENTERLINE FOR ELECTRICAL AND HUB DRAINS
- ① :AVAILABLE SHELF SIZES: 10", 12", 14", 16", & 18"

- Ends add approximately 1" to case height, 1" to the front and 1/2" to the back
- Product on top shelf should be 3" below discharge.



ALL MEASUREMENTS ARE TAKEN PER ASHRAE-72-2005 SPECIFICATIONS. HILLPHOENIX REFRIGERATED DISPLAY CASES FOR SALE IN THE UNITED STATES MEET OR EXCEED DEPARTMENT OF ENERGY 2017 REQUIREMENTS.

**ON4UM-NRG**

Rev. Date	Rev. #	Rev. Title
9-11-18	3	DATA UPDATE
8-1-18	2	NEW STANDARDS

