

3NDML-NRG

4', 6', 8' & 12' Multi-Deck Merchandiser with Synerg-E™
Beverage/Bulk Produce/Bakery/Dairy/Cut Produce/Deli

GENERAL NOTES:

- "---" indicates that feature is not an option on this case model and/or the data is not yet available.

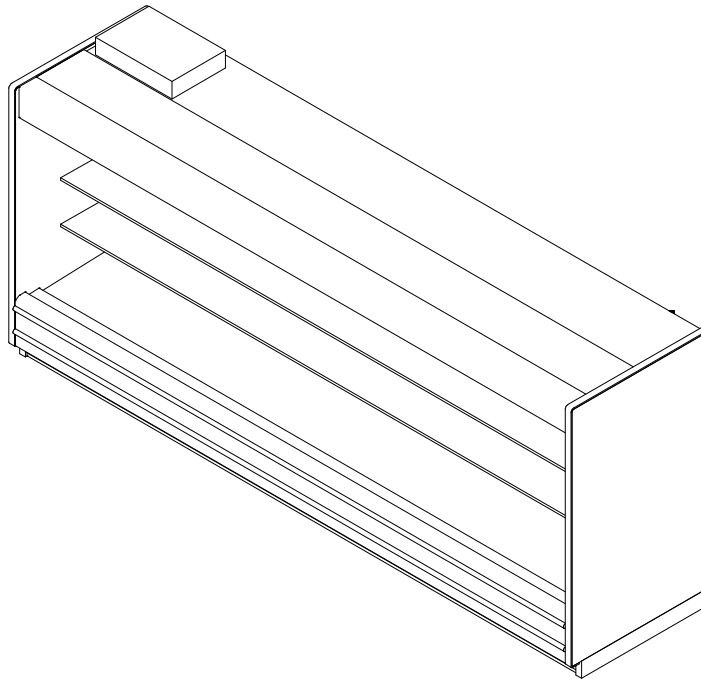

SHIPPING WEIGHT	
Case	Weight
3NDML-NRG	---



ALL MEASUREMENTS ARE TAKEN PER ASHRAE-72-2005 SPECIFICATIONS. HILLPHOENIX REFRIGERATED DISPLAY CASES FOR SALE IN THE UNITED STATES MEET OR EXCEED DEPARTMENT OF ENERGY 2017 REQUIREMENTS.

3NDML-NRG

Rev. Date	Rev. #	Rev. Title
7-30-20	8	ENDVIEW UPDATE
3-24-20	7	DATA UPDATE



3NDML-NRG

4', 6', 8' & 12' Multi-Deck Merchandiser with Synerg-E™
Beverage/Bulk Produce/Bakery/Dairy/Cut Produce/Deli

ELECTRICAL DATA			
Case Length	Fans Per Case	High Efficiency Fans	
		120 Volts	
		Amps	Watts
4'	2	0.36	43.3
6'	3	0.57	65.0
8'	3	0.57	65.0
12'	4	0.72	86.7

LIGHTING DATA						
Case Length	Lights per row	Lights Length	Clearvoyant LED Lighting (Per Light Row)			
			Standard Power (Cornice or Shelf)		High Power (Cornice)	
			120 Volts		120 Volts	
			Amps	Watts	Amps	Watts
4'	1	4'	0.05	5.9	0.12	14.9
6'	2	3'	0.08	9.4	0.20	23.8
8'	2	4'	0.10	11.8	0.25	29.8
12'	3	4'	0.15	17.6	0.37	44.8

GUIDELINES AND CONTROL SETTINGS						
Application	BTUH/ft		Superheat Set Point @ Bulb (°F)	Evaporator (°F)	Discharge Air (°F)	Discharge Air Velocity (FPM)
	Conventional	Parallel				
Bakery/Cut Produce/Dairy/Deli	1396	1343	6 - 8	28	33	210
Beverage/Bulk Produce	1239	1225	6 - 8	32	37	210

DEFROST CONTROLS			
Application	Defrosts Per Day	Timed-Off Defrost	
		Fail-Safe (Min)	Termination Temp (°F)
Bakery/Cut Produce/Dairy/Deli	6	45	47
Beverage/Bulk Produce	2	30	47

NOTES:

- "---" indicates that feature is not an option on this case model and/or the data is not yet available.
- Listed BTUH/ft data represent unlighted shelves. For LED lighting, add 9 BTUH/ft per row of lighted shelving.
- BTUH load increases by 132 BTUH/ft when aftermarket merchandising accessories are utilized.
- Listed evaporator temperature represents unlighted shelves. For lighted shelves and/or aftermarket merchandising accessories, reduce the listed evaporator temperature by 2°F.
- Conventional Discharge Air Control – Recommended Settings: Cut-In Temp = Discharge Air + 2°F; Cut-Out Temp = Discharge Air - 2°F.
- Listed discharge air velocity represents the average velocity at the peak of defrost.
- Temperature and defrost settings listed above are recommended start-up settings. Final operational settings may need to be adjusted for the store condition in which the case operates.



ALL MEASUREMENTS ARE TAKEN PER ASHRAE-72-2005 SPECIFICATIONS. HILLPHOENIX REFRIGERATED DISPLAY CASES FOR SALE IN THE UNITED STATES MEET OR EXCEED DEPARTMENT OF ENERGY 2017 REQUIREMENTS.







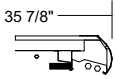
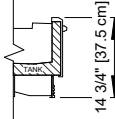

3NDML-NRG

Rev. Date	Rev. #	Rev. Title
7-30-20	8	ENDVIEW UPDATE
3-24-20	7	DATA UPDATE

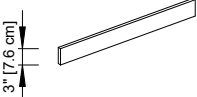
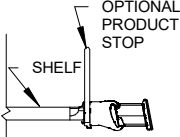
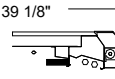
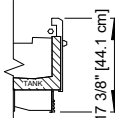
Hillphoenix
A DOVER COMPANY

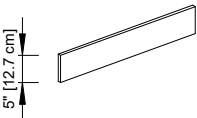
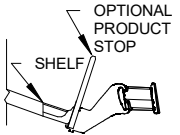
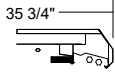
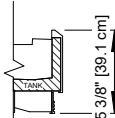
3NDML-NRG

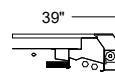
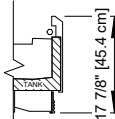
4', 6', 8' & 12' Multi-Deck Merchandiser with Synerg-E™
Beverage/Bulk Produce/Bakery/Dairy/Cut Produce/Deli

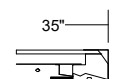
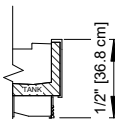
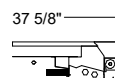
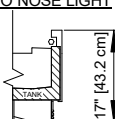
CORNICE OPTIONS	FRONT OPTIONS	SHELF TAG MOLDING OPTIONS	PRODUCT STOP OPTIONS (ONLY APPLICABLE ON SLOTTED TM)	SHELF EDGE ENERGY SAVINGS
<u>CURVED CORNICE</u> 	<u>CLASSIC 2 STANDARD FRONT</u> 	<u>1.25\" STD</u> 	<u>3\" PLEXI PRODUCT STOPS</u> 	<u>ECO BLADE FLAT SHELF</u> 
<u>CURVED CORNICE WITH NIGHT COVER</u> 	<u>CLASSIC 2 17\" FRONT W/ & W/O NOSE LIGHT</u> 	<u>SLOTTED</u> 	<u>5\" PLEXI PRODUCT STOPS</u> 	<u>ECO BLADE ANGLED SHELF</u> 
<u>FACETED CORNICE</u> 	<u>ANGLED FRONT</u> 	<u>ANGLED</u> 	<u>WIRE FENCE PRODUCT STOPS</u> 	
<u>FACETED CORNICE WITH NIGHT COVER</u> 	<u>ANGLED FRONT W/ & W/O NOSE LIGHT</u> 	<u>ANGLED SLOTTED</u> 		
<u>FLAT CORNICE</u> 	<u>FLAT FRONT</u> 			
<u>FLAT CORNICE WITH NIGHT COVER</u> 	<u>17\" FLAT FRONT W/ & W/O NOSE LIGHT</u> 			

NOTES:

- Tag molding materials are PVC, aluminum, or painted aluminum.
- See Ecoblade tech sheet for additional information.



ALL MEASUREMENTS ARE TAKEN PER ASHRAE-72-2005 SPECIFICATIONS. HILLPHOENIX REFRIGERATED DISPLAY CASES FOR SALE IN THE UNITED STATES MEET OR EXCEED DEPARTMENT OF ENERGY 2017 REQUIREMENTS.

3NDML-NRG

Rev. Date	Rev. #	Rev. Title
7-30-20	8	ENDVIEW UPDATE
3-24-20	7	DATA UPDATE



3NDML-NRG

4', 6', 8' & 12' Multi-Deck Merchandiser with Synerg-E™
Beverage/Bulk Produce/Bakery/Dairy/Cut Produce/Deli

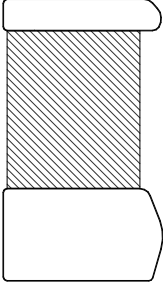
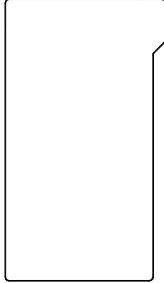
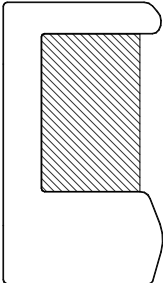
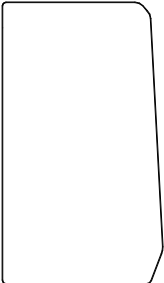
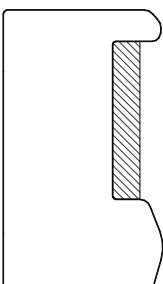
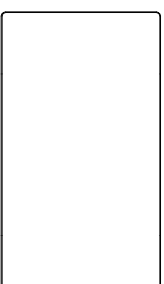
END STYLE OFFERINGS	
<p><u>SUPER VIEW</u></p> 	<p><u>SOLID (EXTENDED CANOPY)</u></p> 
<p><u>FULL VIEW</u></p> 	<p><u>SOLID (STANDARD CANOPY)</u></p> 
<p><u>REDUCED VIEW</u></p> 	<p><u>SQUARE</u></p> 

NOTES:

- Ends shown are for general use only. Shape, size, and appearance are subject to change based on engineering configuration.
- Hatched regions represent glass inserts.
- Ends add approximately 1" to case height, 1/2" to the back & 1" to the front.
- Ends are available with either polymer end trim or metal end trim.



ALL MEASUREMENTS ARE TAKEN PER ASHRAE-72-2005 SPECIFICATIONS. HILLPHOENIX REFRIGERATED DISPLAY CASES FOR SALE IN THE UNITED STATES MEET OR EXCEED DEPARTMENT OF ENERGY 2017 REQUIREMENTS.

3NDML-NRG

Rev. Date	Rev. #	Rev. Title
7-30-20	8	ENDVIEW UPDATE
3-24-20	7	DATA UPDATE



3NDML-NRG

4', 6', 8' & 12' Multi-Deck Merchandiser with Synerg-E™
Beverage/Bulk Produce/Bakery/Dairy/Cut Produce/Deli

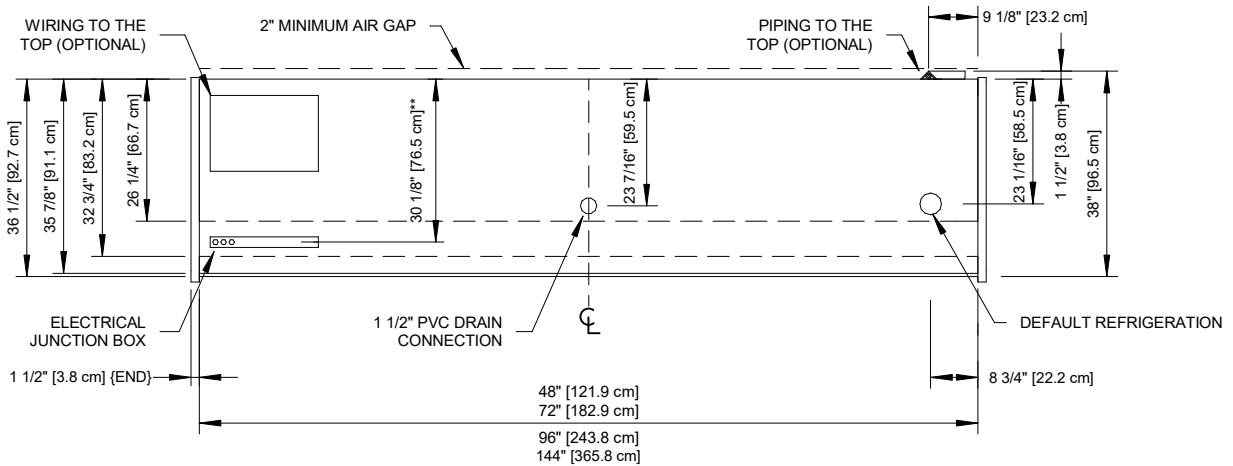
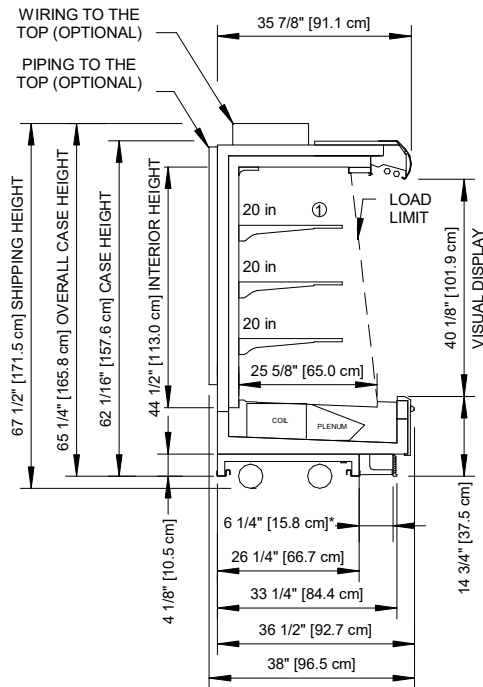

NOTES:

- * : STUP-UP AREA
- ** : RECOMMENDED STUP-UP CENTER LINE FOR ELECTRICAL AND HUB DRAINS
- ① : AVAILABLE SHELF SIZES: 10", 12", 14", 16", 18", 20", 22" & 24"; (3) ROWS OF SHELVES MAX

- Ends add approximately 1" to case height.
- Back panels add approximately 1" to the rear of the case



ALL MEASUREMENTS ARE TAKEN PER ASHRAE-72-2005 SPECIFICATIONS. HILLPHOENIX REFRIGERATED DISPLAY CASES FOR SALE IN THE UNITED STATES MEET OR EXCEED DEPARTMENT OF ENERGY 2017 REQUIREMENTS.

3NDML-NRG

Rev. Date	Rev. #	Rev. Title
7-30-20	8	ENDVIEW UPDATE
3-24-20	7	DATA UPDATE

