

O5UMQA-NRG

8' & 12' Multi-Deck Merchandiser with Synerg-E™
Dairy/Deli/Meat/Produce

SOLOCHILL
MICRO-DISTRIBUTED

GENERAL NOTES:

- "---" indicates that the feature is not an option with this case model and/or the data is not available at this time.
- LED lights only.
- Nose lights are not available.

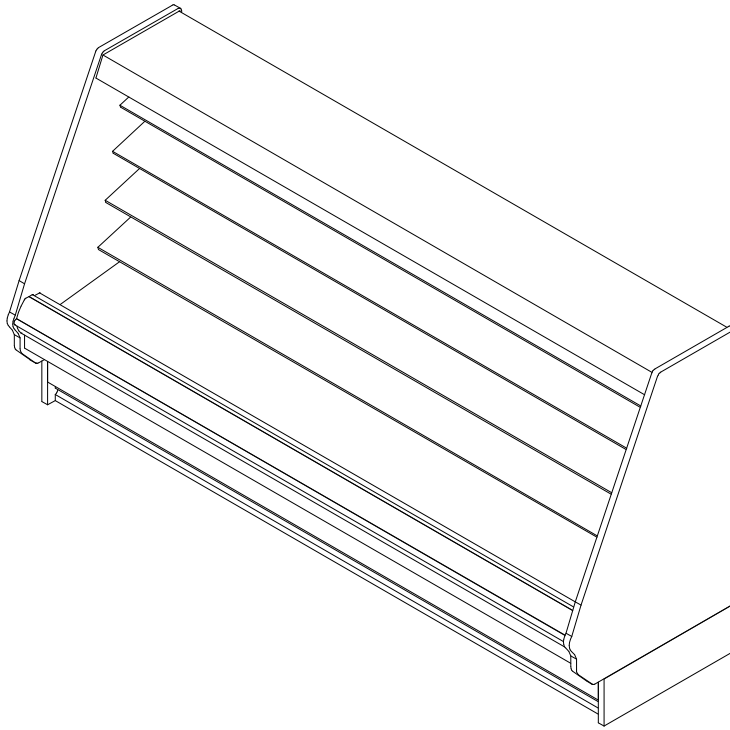

SHIPPING WEIGHT	
Case	Weight
O5UMQA-NRG	---



ALL MEASUREMENTS ARE TAKEN PER ASHRAE-72-2005 SPECIFICATIONS. HILLPHOENIX REFRIGERATED DISPLAY CASES FOR SALE IN THE UNITED STATES MEET OR EXCEED DEPARTMENT OF ENERGY 2017 REQUIREMENTS.

O5UMQA-NRG

Rev. Date	Rev. #	Rev. Title
20-10-20	4	SOLOCHILL V5
3-30-20	3	DATA UPDATE

Hillphoenix
A DOVER COMPANY

O5UMQA-NRG

8' & 12' Multi-Deck Merchandiser with Synerg-E™
Dairy/Deli/Meat/Produce



ELECTRICAL DATA			
Case Length	Fans Per Case	High Efficiency Fans	
		120 Volt	
		Amps	Watts
8'	2	0.40	28.0
12'	3	0.60	42.0

LIGHTING DATA					
Case Length	Lights per row	Clearvoyant v4 LED Lighting (Per Light Row)			
		Standard Power (Cornice or Shelf)		High Power (Cornice Only)	
		120 Volts		120 Volts	
		Amps	Watts	Amps	Watts
8'	2	0.10	11.8	0.05	29.9
12'	3	0.15	17.6	0.37	44.8

DEFROST CONTROLS		
Defrosts Per Day	Timed-Off Defrost	
	Fail-Safe (Min)	Termination Temp (F)
6	30	47

NOTES:

- "----" indicates that the feature is not an option with this case model and/or the data is not available at this time.
- Listed anti-condensate heater data represent an unlighted rear sill.
- Listed BTUH/ft data represent unlighted shelves. For LED lighting, add 9 BTUH/ft per row of lighted shelving.
- Listed discharge air velocity represents the average velocity immediately after defrost.
- Temperature and defrost settings listed above are recommended start-up settings. Final operational settings may need to be adjusted for the store conditions in which the case operates.
- The recommended evaporator temperatures may need to be adjusted based on system setup, store conditions, etc. The minimum recommended evaporator temperature is 4°F below the listed evaporator temperature.
- Timed off defrost is recommended for medium temperature applications.



ALL MEASUREMENTS ARE TAKEN PER ASHRAE-72-2005 SPECIFICATIONS. HILLPHOENIX REFRIGERATED DISPLAY CASES FOR SALE IN THE UNITED STATES MEET OR EXCEED DEPARTMENT OF ENERGY 2017 REQUIREMENTS.

O5UMQA-NRG

Rev. Date	Rev. #	Rev. Title
20-10-20	4	SOLOCHILL V5
3-30-20	3	DATA UPDATE



A DOVER COMPANY

O5UMQA-NRG

8' & 12' Multi-Deck Merchandiser with Synerg-E™
Dairy/Deli/Meat/Produce



SOLOCHILL DATA			@95° Condensing Temperature		
Volts	Phase	Frequency	Wire		
208	1	60	3 Wire + Ground		
Application	Case Length	Evaporator Temp (°F)	Discharge Air (°F)	Discharge Air Velocity (FPM)	
Dairy/Deli/Produce	8'	26	31	180	
Dairy/Deli/Produce	12'	26	31	180	
Meat	8'	24	30	180	
Meat	12'	24	30	180	

Application	Case Length	R448A					
		Condensing Unit Model	MCA	MOP	Required Capacity	THR (BTUH)	Flow Rate
Dairy/Deli/Produce	8'	DA220	17.9	20	9432	11540	3.3
Dairy/Deli/Produce	12'	DA220	18.7	20	14148	17252	4.9
Meat	8'	DA220	17.9	20	9352	11524	3.3
Meat	12'	DA220	18.7	20	14028	17379	4.9

NOTES:

* SoloChill CDU is remote mount only.



ALL MEASUREMENTS ARE TAKEN PER ASHRAE-72-2005 SPECIFICATIONS. HILLPHOENIX REFRIGERATED DISPLAY CASES FOR SALE IN THE UNITED STATES MEET OR EXCEED DEPARTMENT OF ENERGY 2017 REQUIREMENTS.

O5UMQA-NRG

Rev. Date	Rev. #	Rev. Title
20-10-20	4	SOLOCHILL V5
3-30-20	3	DATA UPDATE



A DOVER COMPANY

O5UMQA-NRG

8' & 12' Multi-Deck Merchandiser with Synerg-E™
Dairy/Deli/Meat/Produce



NOTES:

- Front and rear sill height vary with baseframe.
- Extended front sills are required for meat applications to maintain proper product temperature. An extended front has a minimum height of 24" on a 5" baseframe, or 30" on an 11" baseframe.

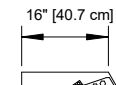
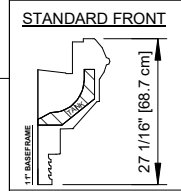
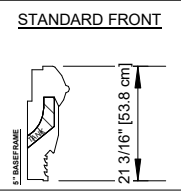
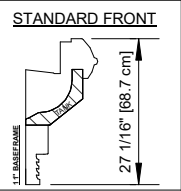
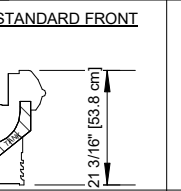
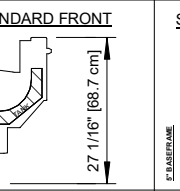
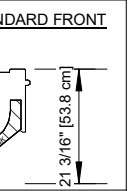
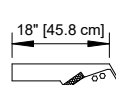
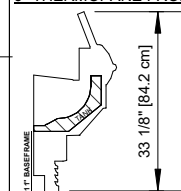
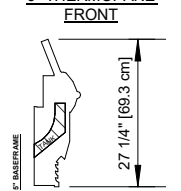
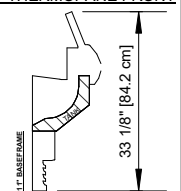
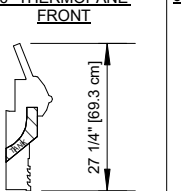
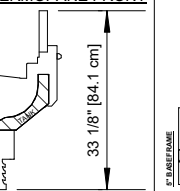
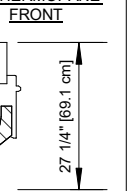
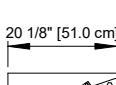
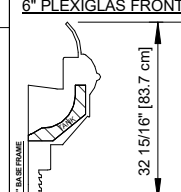
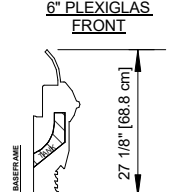
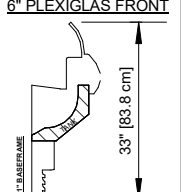
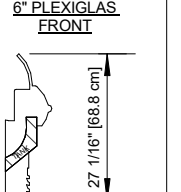
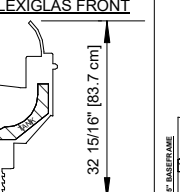
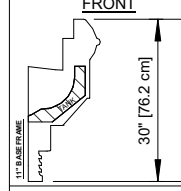
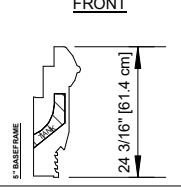
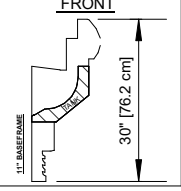
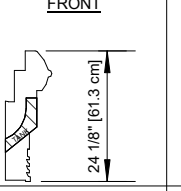
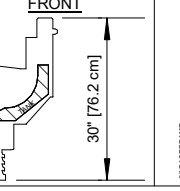
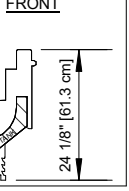
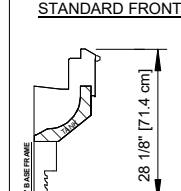
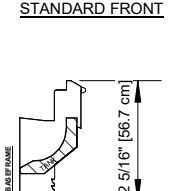
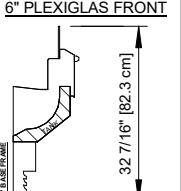
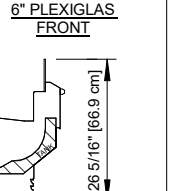
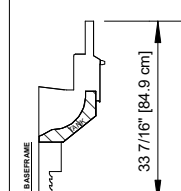
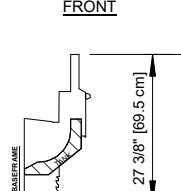
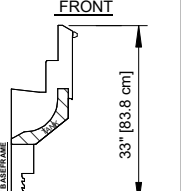
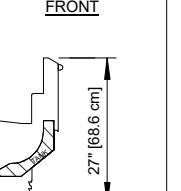
REAR SILL OPTIONS	FRONT OPTIONS						
	ORIGIN 2 FRONT				FLAT FRONT FLAT TOP		
<p>16" REAR SILL (FRONT DISCHARGE)</p> 	STANDARD FRONT  27 1/16" [68.7 cm]	STANDARD FRONT  21 3/16" [53.8 cm]	STANDARD FRONT  27 1/16" [68.7 cm]	STANDARD FRONT  21 3/16" [53.8 cm]	STANDARD FRONT  27 1/16" [68.7 cm]	STANDARD FRONT  21 3/16" [53.8 cm]	
	<p>18" REAR SILL (FRONT DISCHARGE)</p> 	6" THERMOPANE FRONT  33 1/8" [84.2 cm]	6" THERMOPANE FRONT  27 1/4" [69.3 cm]	6" THERMOPANE FRONT  33 1/8" [84.2 cm]	6" THERMOPANE FRONT  27 1/4" [69.3 cm]	6" THERMOPANE FRONT  33 1/8" [84.1 cm]	6" THERMOPANE FRONT  27 1/4" [69.1 cm]
		<p>20" REAR SILL (FRONT DISCHARGE)</p> 	6" PLEXIGLAS FRONT  32 15/16" [83.7 cm]	6" PLEXIGLAS FRONT  27 7/8" [68.8 cm]	6" PLEXIGLAS FRONT  33" [83.8 cm]	6" PLEXIGLAS FRONT  27 1/16" [68.8 cm]	6" PLEXIGLAS FRONT  32 15/16" [83.7 cm]
EXTENDED STANDARD FRONT  30" [76.2 cm]	EXTENDED STANDARD FRONT  24 3/16" [61.4 cm]		EXTENDED STANDARD FRONT  30" [76.2 cm]	EXTENDED STANDARD FRONT  24 1/8" [61.3 cm]	EXTENDED STANDARD FRONT  30" [76.2 cm]	EXTENDED STANDARD FRONT  24 1/8" [61.3 cm]	
FLAT FRONT ANGLED TOP							
STANDARD FRONT  28 1/8" [71.4 cm]	STANDARD FRONT  22 5/16" [56.7 cm]	6" PLEXIGLAS FRONT  32 7/16" [82.3 cm]	6" PLEXIGLAS FRONT  26 5/16" [66.9 cm]				
6" THERMOPANE FRONT  33 7/16" [84.9 cm]	6" THERMOPANE FRONT  27 3/8" [69.5 cm]	EXTENDED STANDARD FRONT  33" [83.8 cm]	EXTENDED STANDARD FRONT  27" [68.6 cm]				



O5UMQA-NRG

ALL MEASUREMENTS ARE TAKEN PER ASHRAE-72-2005 SPECIFICATIONS. HILLPHOENIX REFRIGERATED DISPLAY CASES FOR SALE IN THE UNITED STATES MEET OR EXCEED DEPARTMENT OF ENERGY 2017 REQUIREMENTS.

Rev. Date	Rev. #	Rev. Title
20-10-20	4	SOLOCHILL V5
3-30-20	3	DATA UPDATE



A DOVER COMPANY

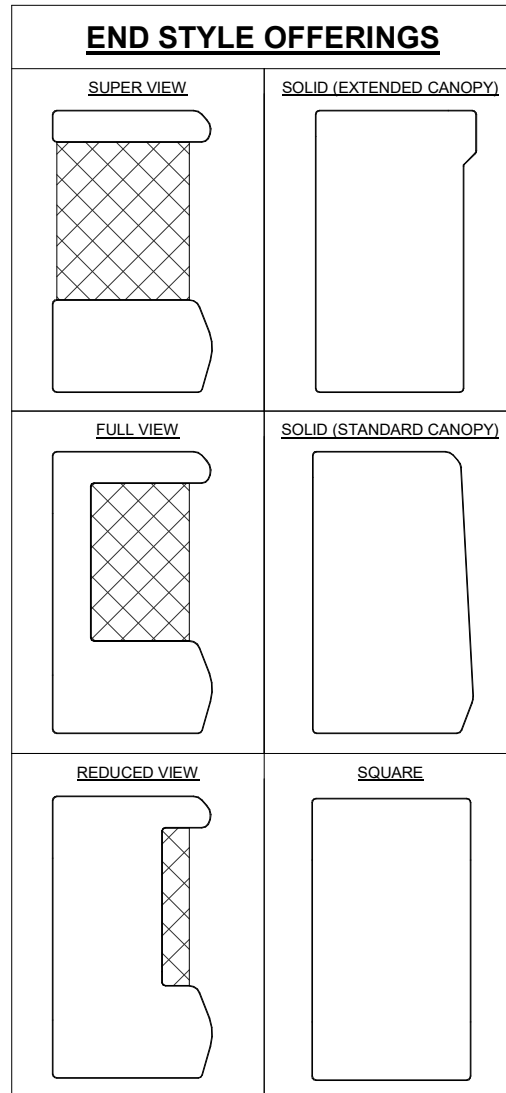

NOTES:

- Ends shown are for general use only. Shape, size, and appearance are subject to change based on engineering configuration.
- Hatched regions represent glass inserts.
- Ends add approximately 1" to case height, 1/2" to the back & 1" to the front.
- Ends are available with either polymer end trim or metal end trim.



COMPONENT

ALL MEASUREMENTS ARE TAKEN PER ASHRAE-72-2005 SPECIFICATIONS. HILLPHOENIX REFRIGERATED DISPLAY CASES FOR SALE IN THE UNITED STATES MEET OR EXCEED DEPARTMENT OF ENERGY 2017 REQUIREMENTS.

O5UMQA-NRG



Rev. Date	Rev. #	Rev. Title
20-10-20	4	SOLOCHILL V5
3-30-20	3	DATA UPDATE

O5UMQA-NRG

8' & 12' Multi-Deck Merchandiser with Synerg-E™
Dairy/Deli/Meat/Produce

SOLOCHILL
MICRO-DISTRIBUTED

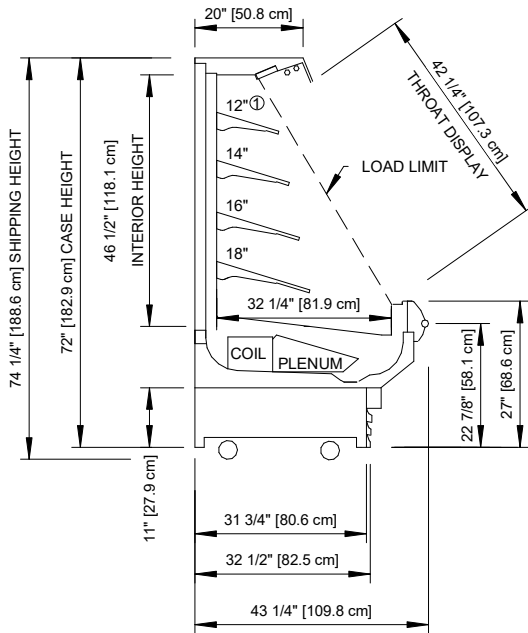

11" BASEFRAME

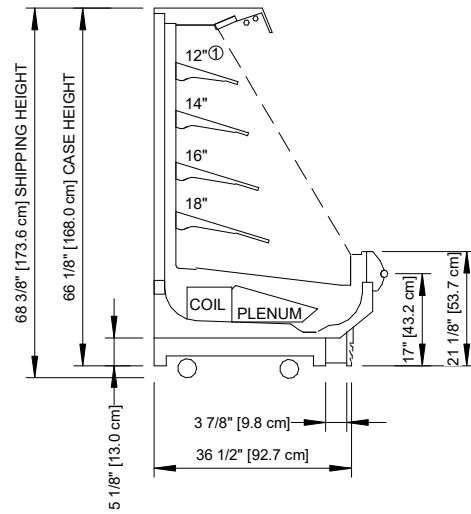

5" BASEFRAME

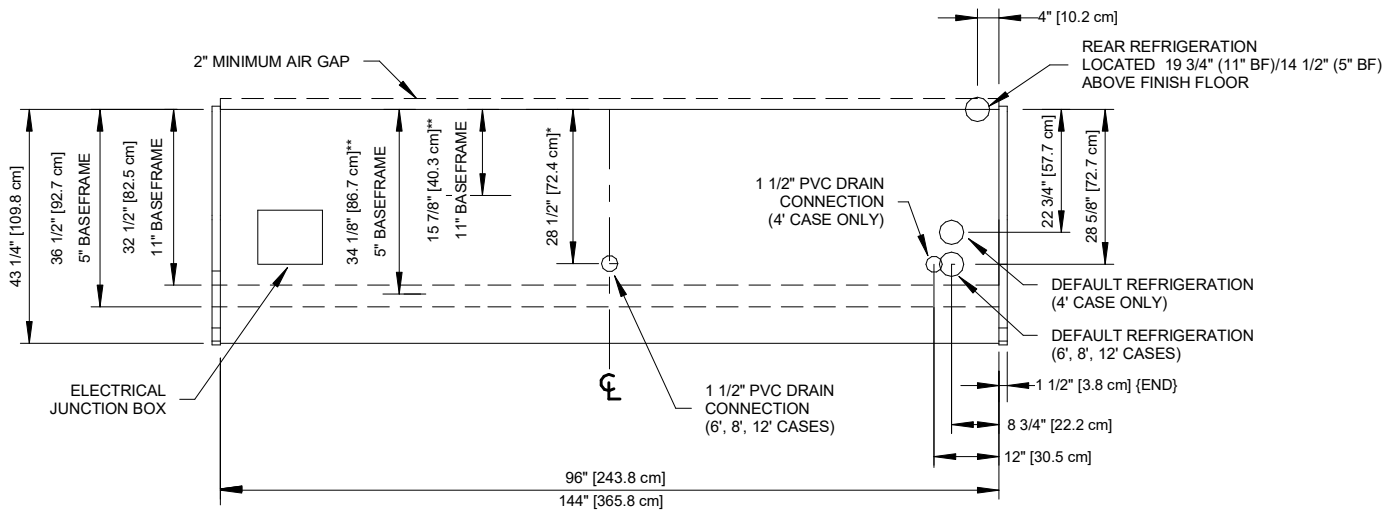

NOTES:

- * :STUB-UP AREA
- ** :RECOMMENDED STUB-UP CENTERLINE FOR ELECTRICAL AND HUB DRAINS AVAILABLE UPON REQUEST
- Ⓢ :AVAILABLE SHELF SIZES: 10", 12", 14", 16" & 18"

- Ends add approximately 1 inch to case height, 1" to the front and 1/2" to the back.
- Product on top shelf should be 3 inches below discharge.



O5UMQA-NRG

ALL MEASUREMENTS ARE TAKEN PER ASHRAE-72-2005 SPECIFICATIONS. HILLPHOENIX REFRIGERATED DISPLAY CASES FOR SALE IN THE UNITED STATES MEET OR EXCEED DEPARTMENT OF ENERGY 2017 REQUIREMENTS.

Rev. Date	Rev. #	Rev. Title
20-10-20	4	SOLOCHILL V5
3-30-20	3	DATA UPDATE

