

# ON5UMQA-NRG

8' & 12' Narrow MultiDeck Utility Merchandiser with Synergy™ Dairy

**SOLOCHILL**  
MICRO-DISTRIBUTED

GENERAL NOTES

- "----" indicates that the feature is not an option for this case model and/or the data is not yet available.

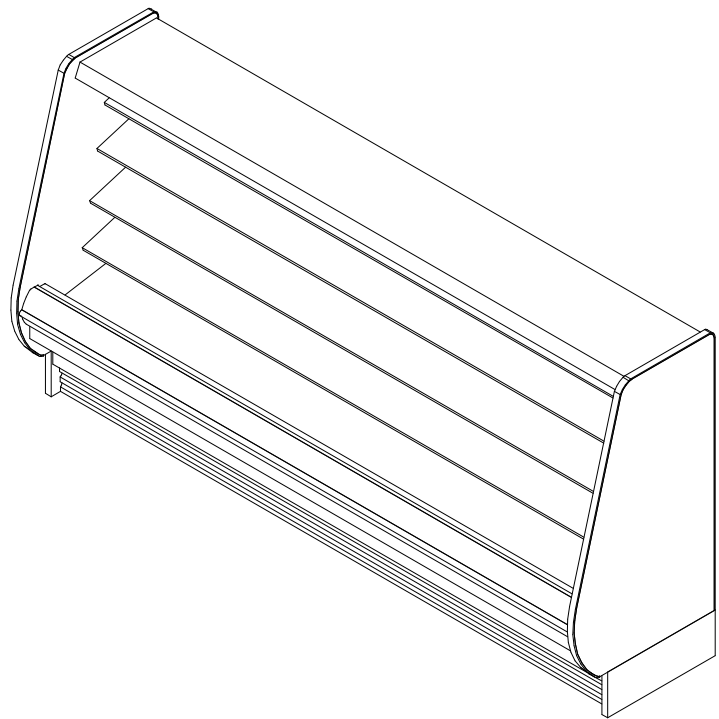

SHIPPING WEIGHT	
Case	Weight
ON5UMQA-NRG	----



ALL MEASUREMENTS ARE TAKEN PER ASHRAE-72-2005 SPECIFICATIONS. HILLPHOENIX REFRIGERATED DISPLAY CASES FOR SALE IN THE UNITED STATES MEET OR EXCEED DEPARTMENT OF ENERGY 2017 REQUIREMENTS.

## ON5UMQA-NRG

Rev. Date	Rev. #	Rev. Title
9-30-20	2	SOLOCHILL V5
9-19-19	1	SOLOCHILL V4

**Hillphoenix**  
A DOVER COMPANY

# ON5UMQA-NRG

8' & 12' Narrow MultiDeck Utility Merchandiser with Synergy™ Dairy



ELECTRICAL DATA			
Case Length	Fans Per Case	High Efficiency Fans	
		120 Volts	
		Amps	Watts
8'	2	0.32	22.0
12'	3	0.48	33.0

LIGHTING DATA						
Case Length	Lights per row	Lights Length	Clearvoyant LED Lighting (Per Light Row)			
			Standard Power (Cornice or Shelf)		High Power (Cornice)	
			120 Volts		120 Volts	
			Amps	Watts	Amps	Watts
8'	2	4'	0.10	11.8	0.25	29.9
12'	3	4'	0.15	17.6	0.37	44.8

DEFROST CONTROLS		
Defrosts Per Day	Timed-Off Defrost	
	Fail-Safe (Min)	Termination Temp (°F)
6	30	47

**Notes:**

- "---" indicates that the feature is not an option with this case model.
- Listed discharge air velocity represents the average velocity immediately after defrost.
- Temperature and defrost settings listed above are recommended start-up settings. Final operational settings may need to be adjusted for the store conditions in which the case operates.



ALL MEASUREMENTS ARE TAKEN PER ASHRAE-72-2005 SPECIFICATIONS. HILLPHOENIX REFRIGERATED DISPLAY CASES FOR SALE IN THE UNITED STATES MEET OR EXCEED DEPARTMENT OF ENERGY 2017 REQUIREMENTS.

## ON5UMQA-NRG

Rev. Date	Rev. #	Rev. Title
9-30-20	2	SOLOCHILL V5
9-19-19	1	SOLOCHILL V4



A DOVER COMPANY

# ON5UMQA-NRG

8' & 12' Narrow MultiDeck Utility Merchandiser with Synergy™ Dairy



SOLOCHILL DATA			@95° Condensing Temperature	
Volts	Phase	Frequency	Wire	
208	1	60	3 Wire + Ground	
Application	Case Length	Evaporator Temp (°F)	Discharge Air (°F)	Discharge Air Velocity (FPM)
Dairy	8'	26	31	180
Dairy	12'	26	31	180

Application	Case Length	R448A					
		Condensing Unit Model	MCA	MOP	Required Capacity	THR (BTUH)	Flow Rate
Dairy	8'	DA220	18.1	20	9432	11540	3.3
Dairy	12'	DA220	19.0	20	14148	17252	4.9

**NOTES:**

\* SoloChill CDU is remote mount only.



ALL MEASUREMENTS ARE TAKEN PER ASHRAE-72-2005 SPECIFICATIONS. HILLPHOENIX REFRIGERATED DISPLAY CASES FOR SALE IN THE UNITED STATES MEET OR EXCEED DEPARTMENT OF ENERGY 2017 REQUIREMENTS.

## ON5UMQA-NRG

Rev. Date	Rev. #	Rev. Title
9-30-20	2	SOLOCHILL V5
9-19-19	1	SOLOCHILL V4



A DOVER COMPANY

# ON5UMQA-NRG

8' & 12' Narrow MultiDeck Utility Merchandiser with Synergy™

Dairy

**SOLOCHILL**  
MICRO-DISTRIBUTED

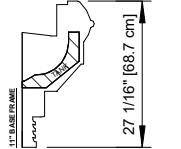
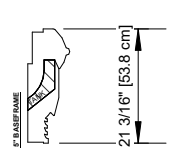
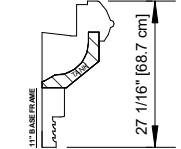
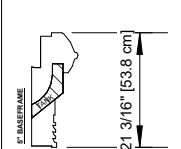
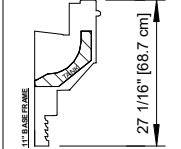
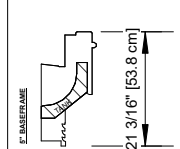
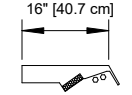
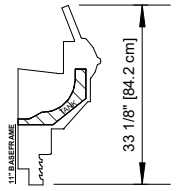
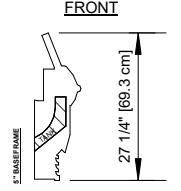
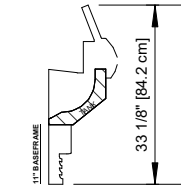
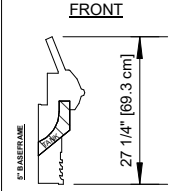
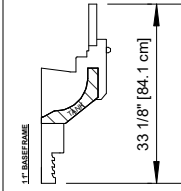
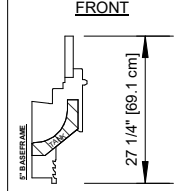
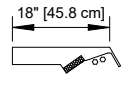
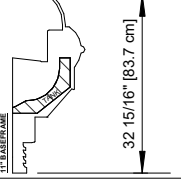
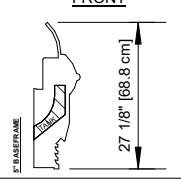
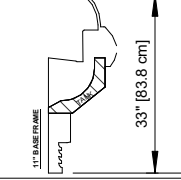
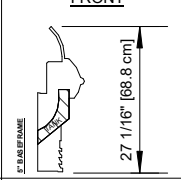
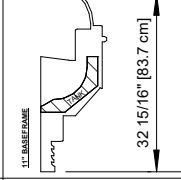
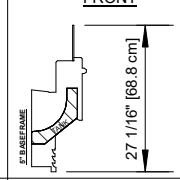
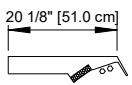
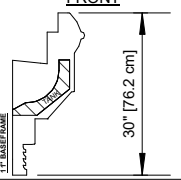
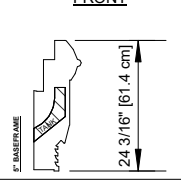
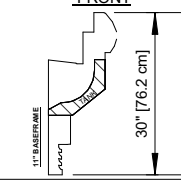
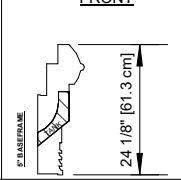
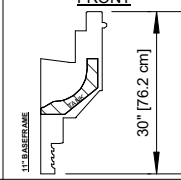
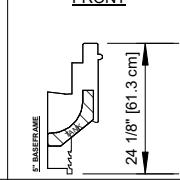
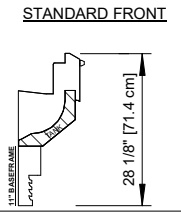
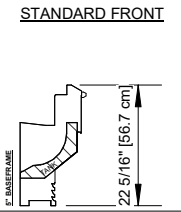
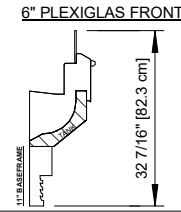
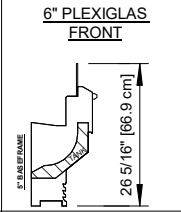
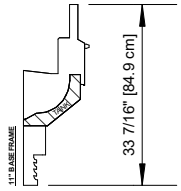
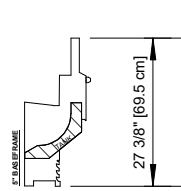
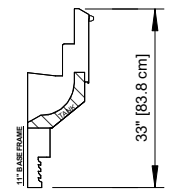
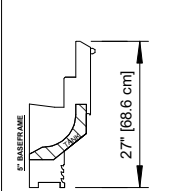
REAR SILL OPTIONS	FRONT OPTIONS					
	ORIGIN 2 FRONT				FLAT FRONT FLAT TOP	
	STANDARD FRONT	STANDARD FRONT	STANDARD FRONT	STANDARD FRONT	STANDARD FRONT	STANDARD FRONT
16" REAR SILL (FRONT DISCHARGE)						
	<b>6" THERMOPANE FRONT</b>	<b>6" THERMOPANE FRONT</b>	<b>6" THERMOPANE FRONT</b>	<b>6" THERMOPANE FRONT</b>	<b>6" THERMOPANE FRONT</b>	<b>6" THERMOPANE FRONT</b>
18" REAR SILL (FRONT DISCHARGE)						
	<b>6" PLEXIGLAS FRONT</b>	<b>6" PLEXIGLAS FRONT</b>	<b>6" PLEXIGLAS FRONT</b>	<b>6" PLEXIGLAS FRONT</b>	<b>6" PLEXIGLAS FRONT</b>	<b>6" PLEXIGLAS FRONT</b>
20" REAR SILL (FRONT DISCHARGE)						
	<b>EXTENDED STANDARD FRONT</b>	<b>EXTENDED STANDARD FRONT</b>	<b>EXTENDED STANDARD FRONT</b>	<b>EXTENDED STANDARD FRONT</b>	<b>EXTENDED STANDARD FRONT</b>	<b>EXTENDED STANDARD FRONT</b>
						
	<b>FLAT FRONT ANGLED TOP</b>					
	<b>STANDARD FRONT</b>	<b>STANDARD FRONT</b>	<b>6" PLEXIGLAS FRONT</b>	<b>6" PLEXIGLAS FRONT</b>		
						
	<b>6" THERMOPANE FRONT</b>	<b>6" THERMOPANE FRONT</b>	<b>EXTENDED STANDARD FRONT</b>	<b>EXTENDED STANDARD FRONT</b>		
						



ALL MEASUREMENTS ARE TAKEN PER ASHRAE-72-2005 SPECIFICATIONS. HILLPHOENIX REFRIGERATED DISPLAY CASES FOR SALE IN THE UNITED STATES MEET OR EXCEED DEPARTMENT OF ENERGY 2017 REQUIREMENTS.

## ON5UMQA-NRG

Rev. Date	Rev. #	Rev. Title
9-30-20	2	SOLOCHILL V5
9-19-19	1	SOLOCHILL V4

**Hillphoenix**  
A DOVER COMPANY

# ON5UMQA-NRG

8' & 12' Narrow MultiDeck Utility Merchandiser with Synergy™ Dairy

**SOLOCHILL**  
MICRO-DISTRIBUTED

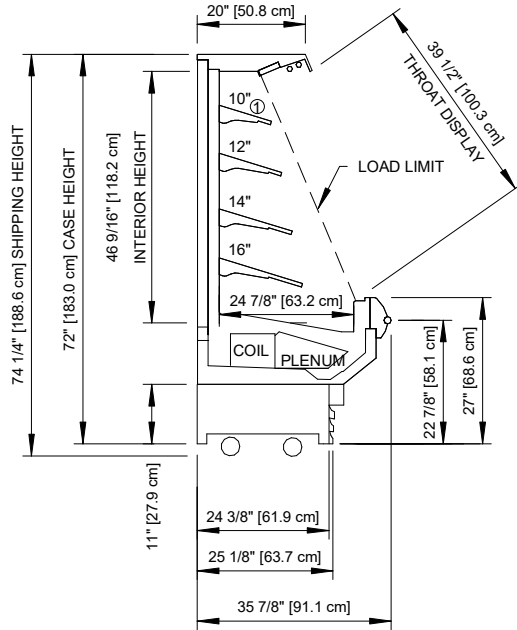

**11" BASEFRAME**

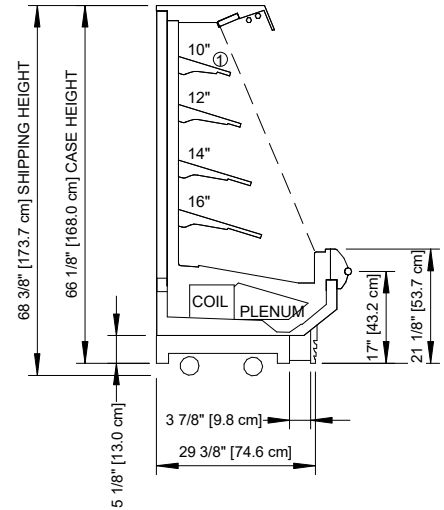

**5" BASEFRAME**

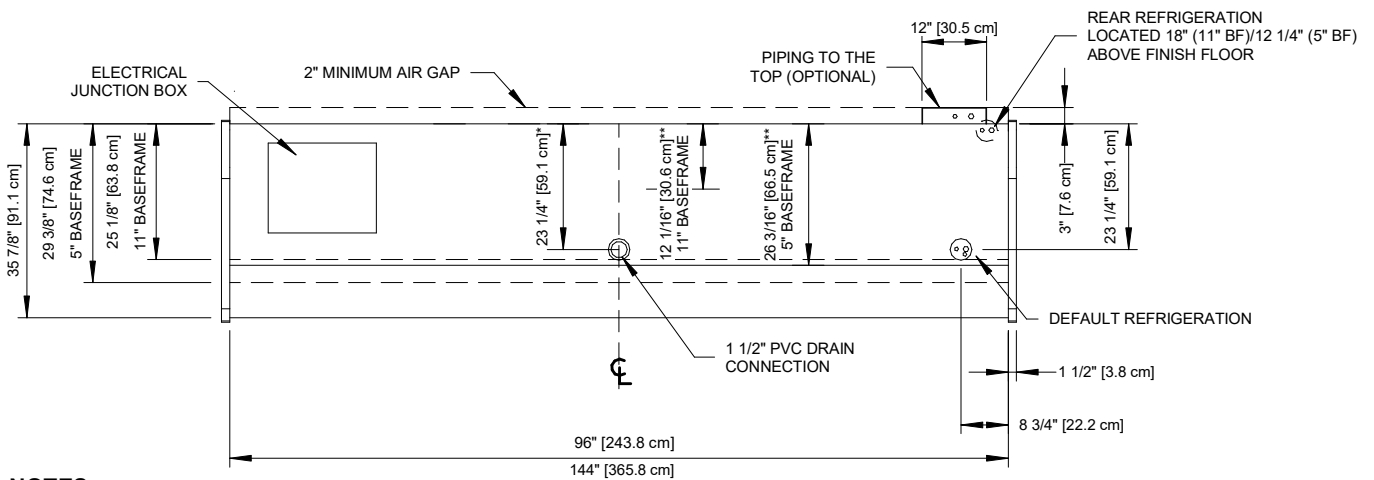

**NOTES:**

- \* :STUB-UP AREA
- \*\* :RECOMMENDED STUB-UP CENTERLINE FOR ELECTRICAL AND HUB DRAINS
- ① :AVAILABLE SHELF SIZES: 10", 12", 14", 16", & 18"

- Ends add approximately 1" to case height, 1" to the front and 1/2" to the back
- Product on top shelf should be 3" below discharge.



**ON5UMQA-NRG**

ALL MEASUREMENTS ARE TAKEN PER ASHRAE-72-2005 SPECIFICATIONS. HILLPHOENIX REFRIGERATED DISPLAY CASES FOR SALE IN THE UNITED STATES MEET OR EXCEED DEPARTMENT OF ENERGY 2017 REQUIREMENTS.

Rev. Date	Rev. #	Rev. Title
9-30-20	2	SOLOCHILL V5
9-19-19	1	SOLOCHILL V4

**Hillphoenix**  
A DOVER COMPANY